

ALUMIL

Building excellence every day

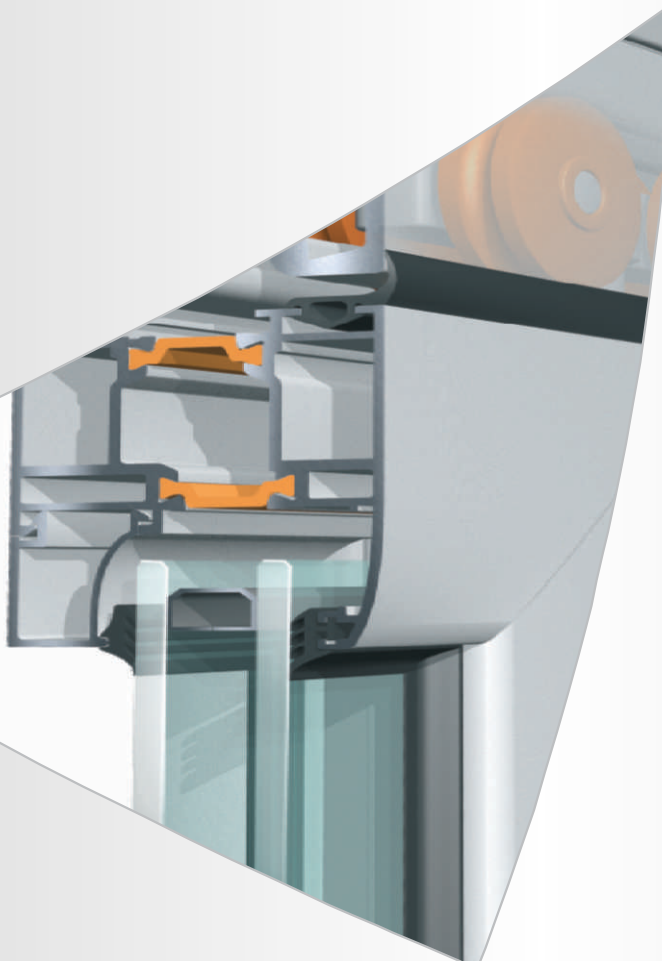

ALUMIL ■ ■ ■ ■ ■ **MI9800**
■ ■ ■ ■ ■ **Accordion Alutherm**

V.1/M19800-12/13

Objašnjenje simbola Symbol Explanation	3-4
Indeks profila Profile Index	5-8
Profili 1:1 Profiles 1:1	9-12
Osnovna tipologija Basic Typologies	13-16
Presjeci 1:1 Sections 1:1	17-26
Detalji Details	27-30
Sječenje Cuttings	31-34
Prinori i zaptivke Accessories Gaskets	35-38
Opšte informacije General Information	39-42

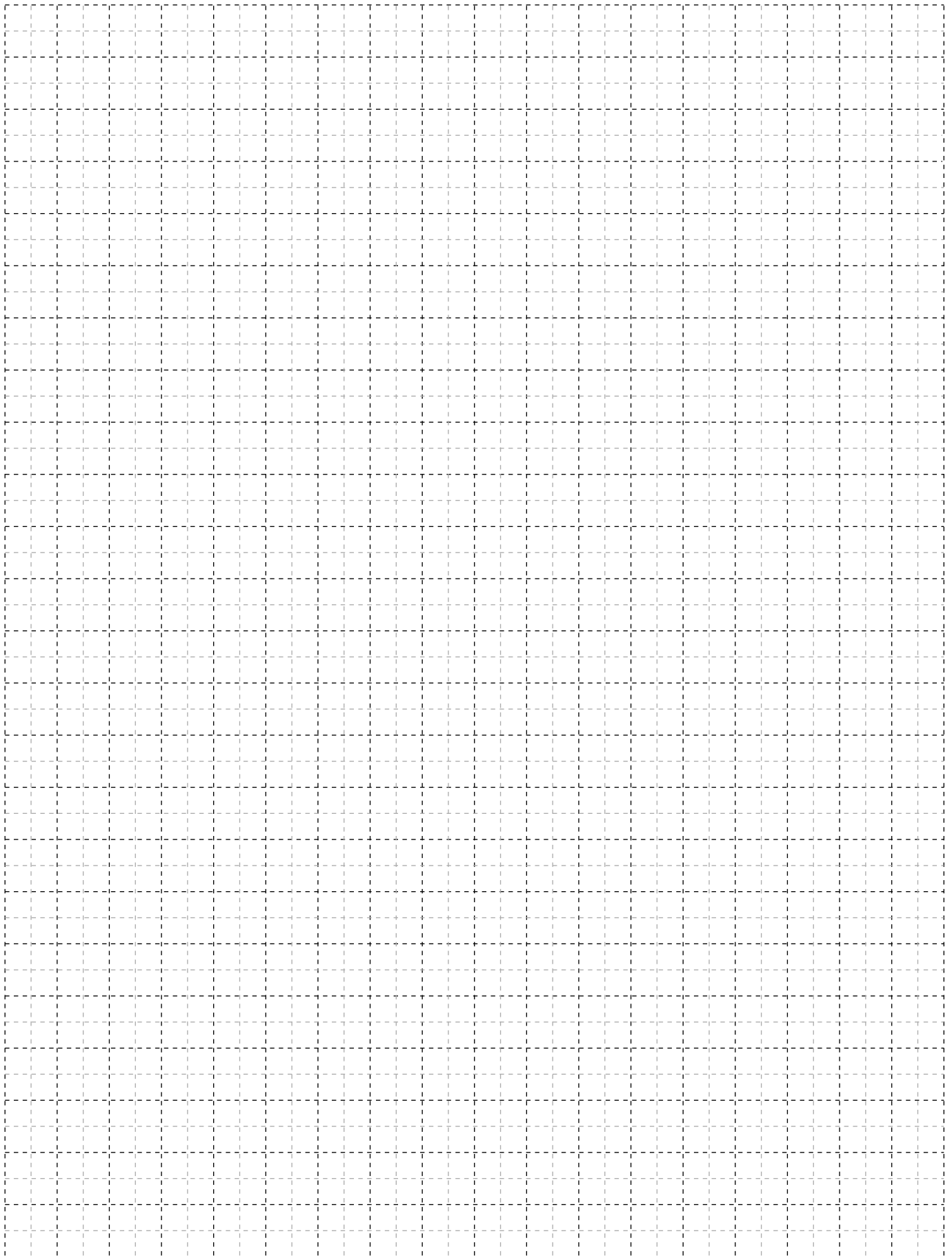









Objašnjenje simbola Symbol Explanation

 = pomoćna spojnica	 = ojačanje za ugao	 = zaptivna traka
 = kruta spojnica	 = ojačanje za T spoj	 = širina
 = spojnica sa klinima	 = specijalno	 = visina
 = brza spojnica	 = spojnica u paru	 = vanjski obim
 = aluminijumska livena spojnica	 = završni poklopac	 = osnovni obim
 = spojnica	 = pila	 = moment inercije x-x
 = ugao za lajsnu	 = glodalo	 = moment inercije y-y
 = spojnica sa promjenljivim uglom	 = gumeni čekić	 = težina
 = livena spojnica za T spoj	 = burgija	 = profil
 = spojnica za T spoj	 = presa	 = broj strane
 = distancer	 = zaptivač	* = nema oznake
 = spojnica za T spoj podešavajuća	 = lijepak	
 = Spojnica sa oprugom		
 = Inox spojnica		
 = Spojnica vertikalne i horizontale		
 = Kooltherm		

Indeks profila
Profile Index

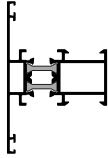

		mm	mm	mm	mm	cm ⁴	cm ⁴	gr/m	#
	M19832	53,1	57,5	387	167	22,88	10,82	1848	10
	M19833	30	50	265	60	9,48	3,06	1054	10
	M19834	62,5	50	339	113	15,54	15,68	1491	10
	M19835	38,8	53,2	252	39	8,55	2,24	883	10
	M19838	93,9	57,5	559	198	36,57	80,39	2642	11
	M19847	41	70	343	142	23,50	10,93	1867	11
	M9805	22,3	21,8	114	0	0,34	0,46	226	11
	M9806	15	10,7	70	0	0,05	0,18	249	11
	M9112	19,45	25,8	140	30	0,53	0,29	239	12
	M9311	29,5	22	182	51	0,90	0,96	304	12
	M9312	26,5	19,3	143	35	0,31	0,68	241	12
	M9836	37,3	7,4	92	38	0,01	0,69	178	12

									
		mm	mm	mm	mm	cm ⁴	cm ⁴	gr/m	
	M19850	46	70	367,2	104	7,14	9,23	1088	12

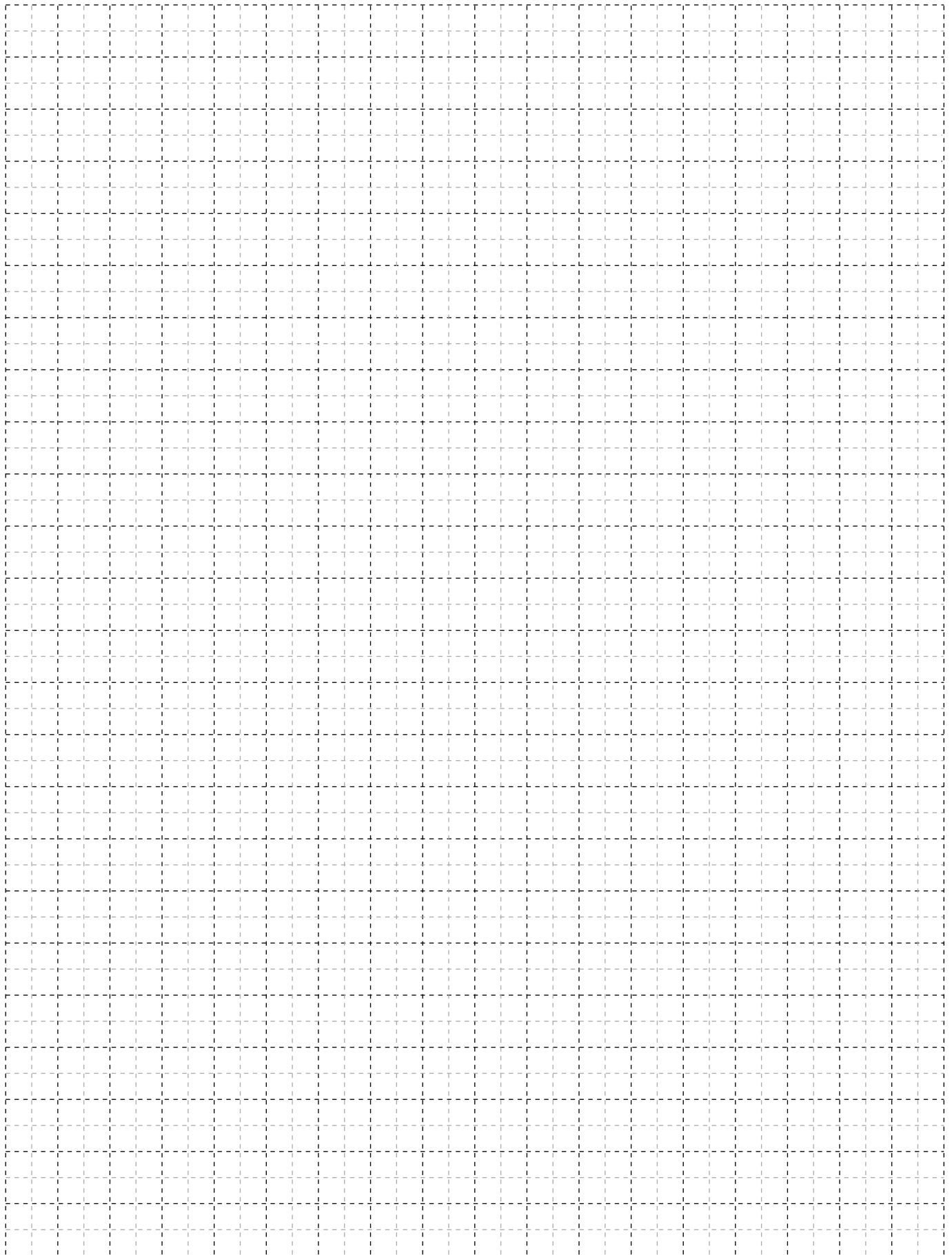

Profili 1:1
Profiles 1:1

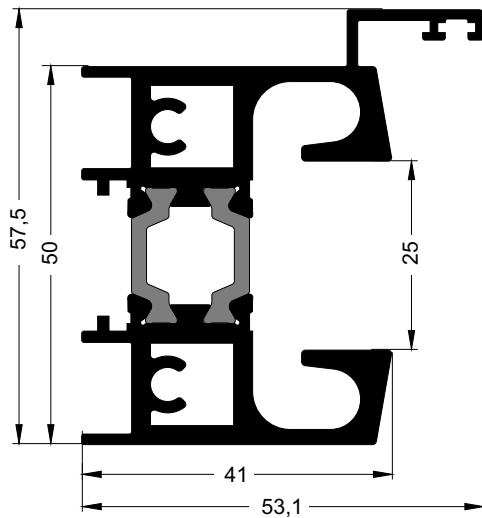

M19832	
Donja vođica Bottom frame guide	
Vanjski obim External perimeter	387 mm
Obim osnove Primary perimeter	167 mm
Moment inercije x-x Moment of inertia x-x	22,88 cm ⁴
Moment inercije y-y Moment of inertia y-y	10,82 cm ⁴
Težina Weight	1848 gr/m

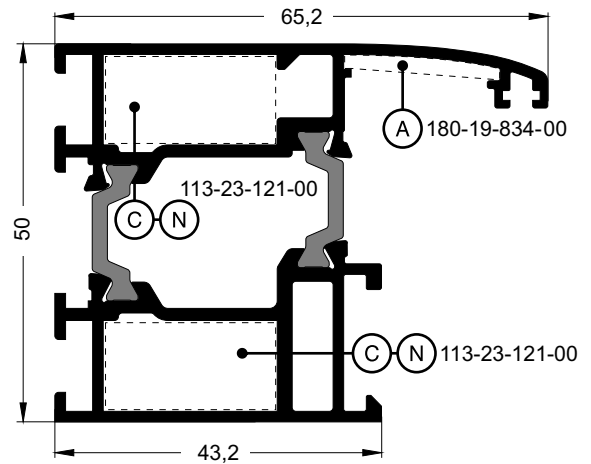

M19834	
Kriilo Sash	
Vanjski obim External perimeter	339 mm
Obim osnove Primary perimeter	113 mm
Moment inercije x-x Moment of inertia x-x	15,54 cm ⁴
Moment inercije y-y Moment of inertia y-y	15,68 cm ⁴
Težina Weight	1491 gr/m
Kruta spojnica Crimp cleat	113-23-121-00 vani, unutra outer & inner
Pomoćna spojnica Alignment corner	180-19-834-00 vani ou.

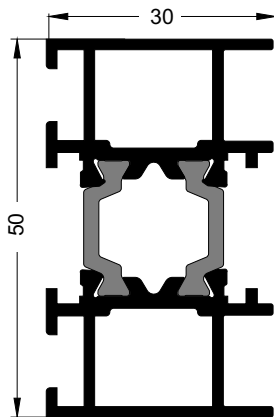

M19833	
Vertikalni štok Vertical frame	
Vanjski obim External perimeter	265 mm
Obim osnove Primary perimeter	60 mm
Moment inercije x-x Moment of inertia x-x	9,48 cm ⁴
Moment inercije y-y Moment of inertia y-y	3,06 cm ⁴
Težina Weight	1054 gr/m

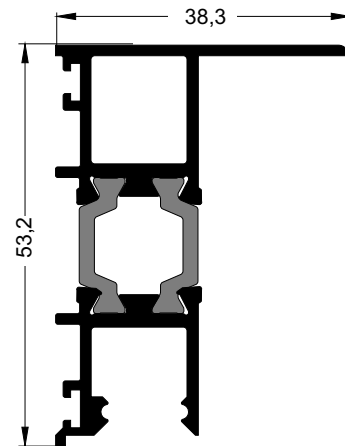

M19835	
Prihvatni profil Cornice	
Vanjski obim External perimeter	252 mm
Obim osnove Primary perimeter	39 mm
Moment inercije x-x Moment of inertia x-x	8,55 cm ⁴
Moment inercije y-y Moment of inertia y-y	2,24 cm ⁴
Težina Weight	883 gr/m

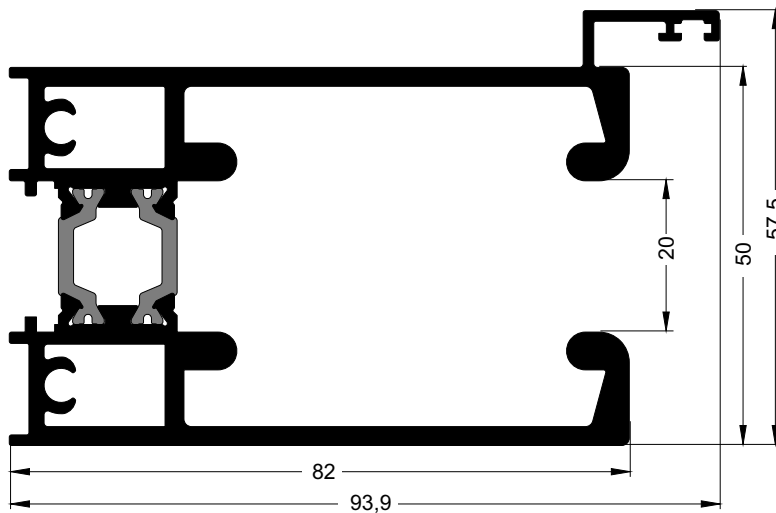

M19838	
Gornja vodica Cornice	
Vanjski obim External perimeter	559 mm
Obim osnove Primary perimeter	198 mm
Moment inercije x-x Moment of inertia x-x	36,57 cm ⁴
Moment inercije y-y Moment of inertia y-y	80,39 cm ⁴
Težina Weight	2642 gr/m

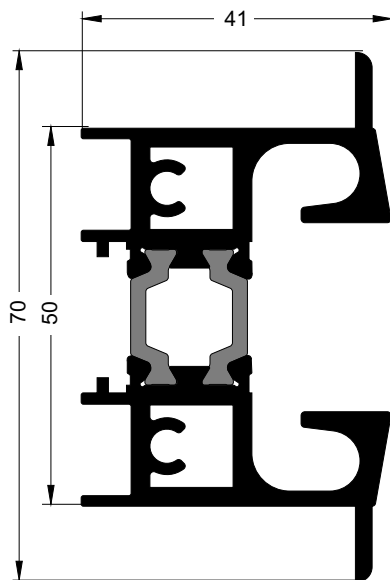

M19847	
Donja vodica Bottom frame guide	
Vanjski obim External perimeter	342 mm
Osnovni obim Primary perimeter	142 mm
Moment inercije x-x Moment of inertia x-x	23,50 cm ⁴
Moment inercije y-y Moment of inertia y-y	10,93 cm ⁴
Težina Weight	1867 gr/m

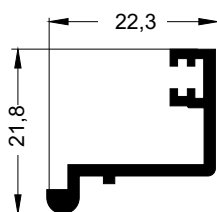

M9805	
Lajsna Water-proofing glazing bead	
Vanjski obim External perimeter	114 mm
Osnovni obim Primary perimeter	0 mm
Moment inercije x-x Moment of inertia x-x	0,34 cm ⁴
Moment inercije y-y Moment of inertia y-y	0,46 cm ⁴
Težina Weight	226 gr/m

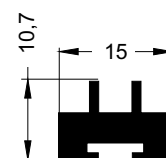

M9806	
Nosac četkice Plug insert for brushes	
Vanjski obim External perimeter	70 mm
Osnovni obim Primary perimeter	0 mm
Moment inercije x-x Moment of inertia x-x	0,05 cm ⁴
Moment inercije y-y Moment of inertia y-y	0,18 cm ⁴
Težina Weight	249 gr/m

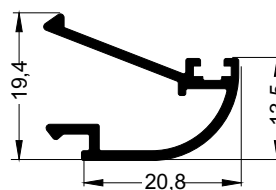
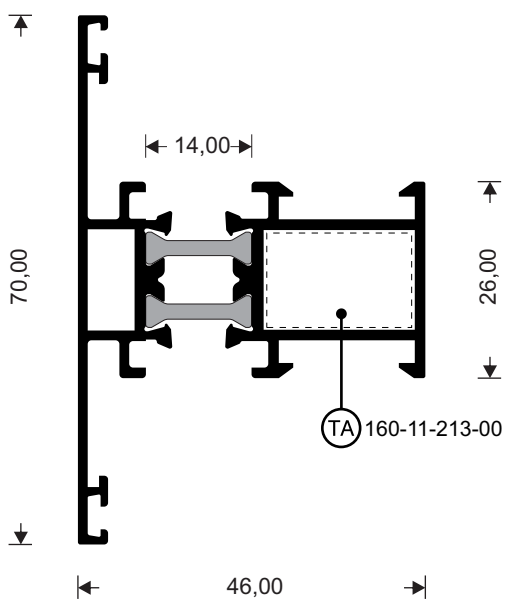

M9112	
Lajsna za staklo Round glazing bead	
Vanjski obim External perimeter	140 mm
Osnovni obim Primary perimeter	30 mm
Moment inercije x-x Moment of inertia x-x	0,29 cm ⁴
Moment inercije y-y Moment of inertia y-y	0,53 cm ⁴
Težina Weight	239 gr/m

M19850	
T prečka T profile	
Vanjski obim External perimeter	367,2 mm
Osnovni obim Primary perimeter	104 mm
Moment inercije x-x Moment of inertia x-x	7,14 cm ⁴
Moment inercije y-y Moment of inertia y-y	9,23 cm ⁴
Težina Weight	1088 gr/m
T spojnica T connector	160-11-213-00 unutra outer

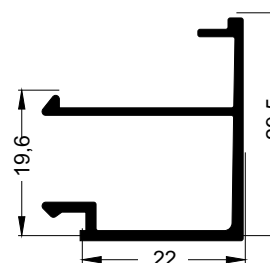

M9311	
Lajsna za staklo Flat glazing bead	
Vanjski obim External perimeter	182 mm
Obim osnove Primary perimeter	51 mm
Moment inercije x-x Moment of inertia x-x	0,96 cm ⁴
Moment inercije y-y Moment of inertia y-y	0,90 cm ⁴
Težina Weight	304 gr/m

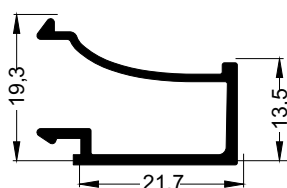

M9312	
Lajsna za staklo Flat glazing bead	
Vanjski obim External perimeter	143 mm
Obim osnove Primary perimeter	35 mm
Moment inercije x-x Moment of inertia x-x	0,31 cm ⁴
Moment inercije y-y Moment of inertia y-y	0,68 cm ⁴
Težina Weight	241 gr/m

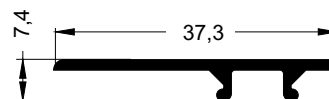

M9836	
Poklopac Cornice glazing bead	
Vanjski obim External perimeter	92 mm
Obim osnove Primary perimeter	38 mm
Moment inercije x-x Moment of inertia x-x	0,01 cm ⁴
Moment inercije y-y Moment of inertia y-y	0,69 cm ⁴
Težina Weight	178 gr/m

Osnovna tipologija

Basic Typologies

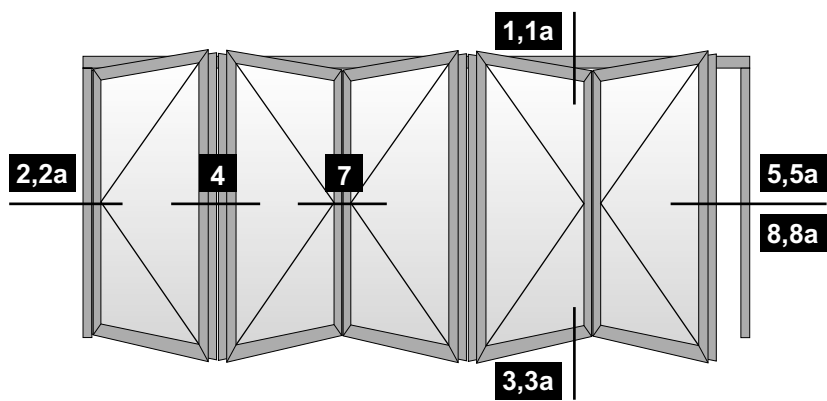
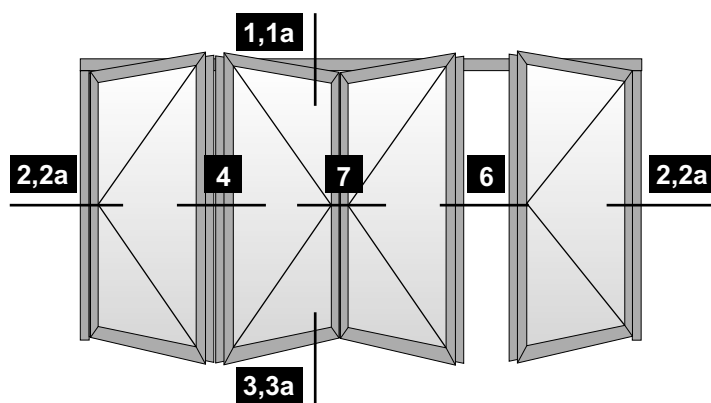
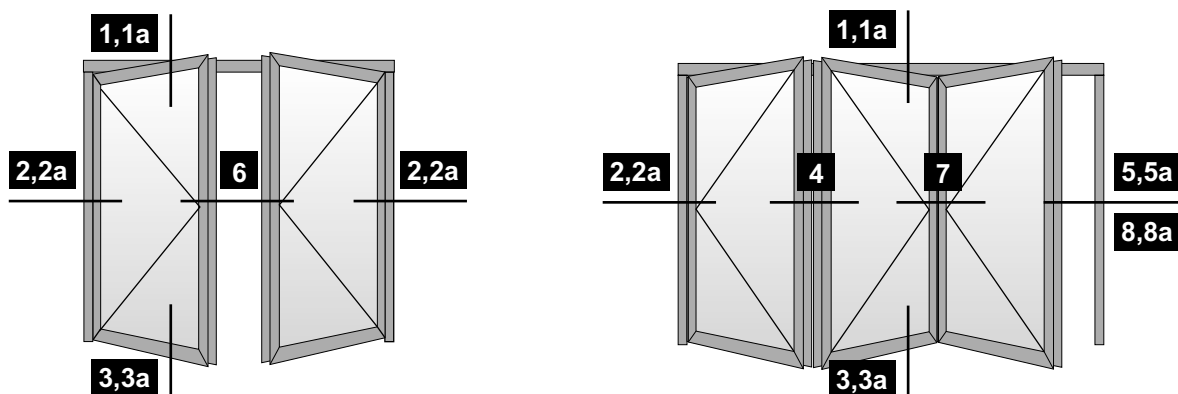

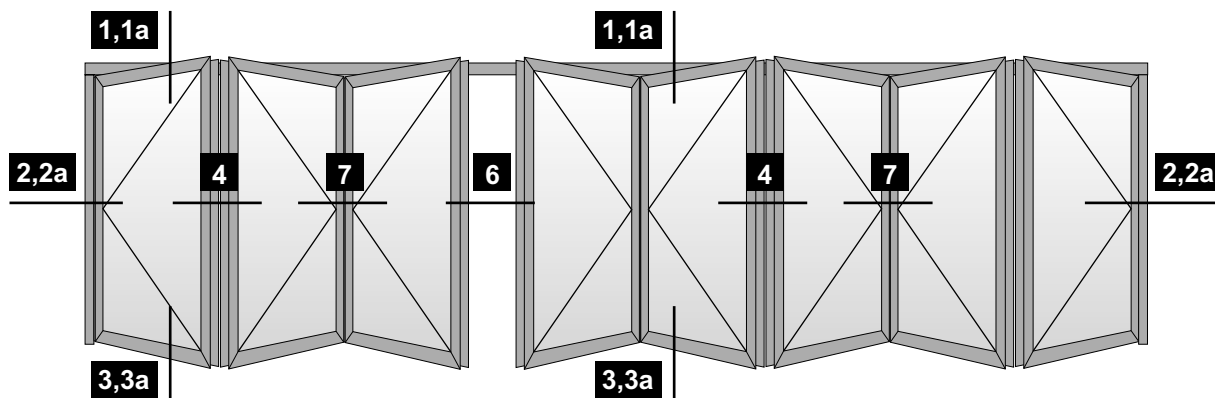
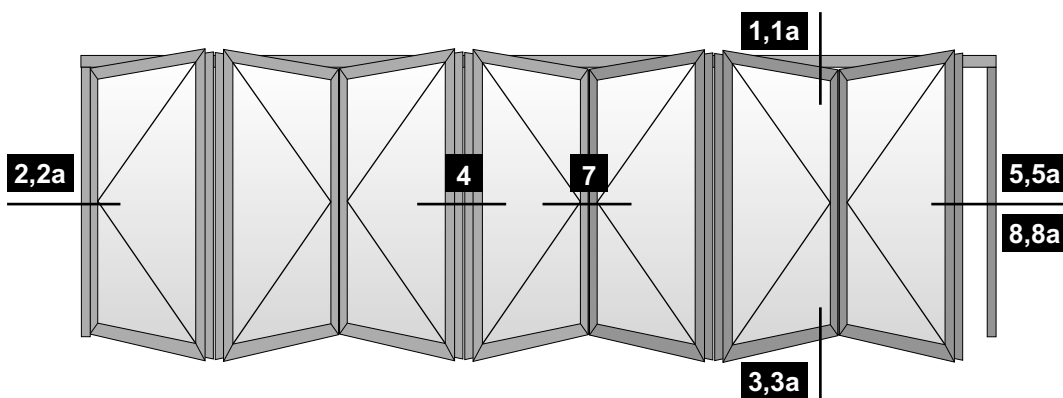
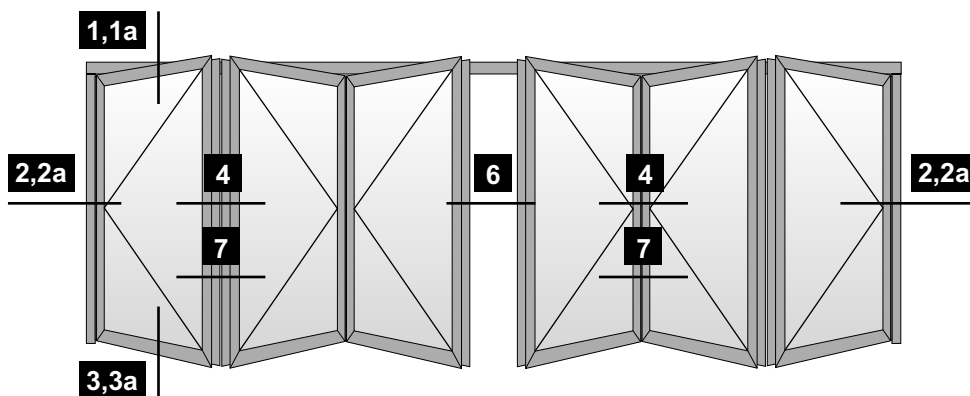

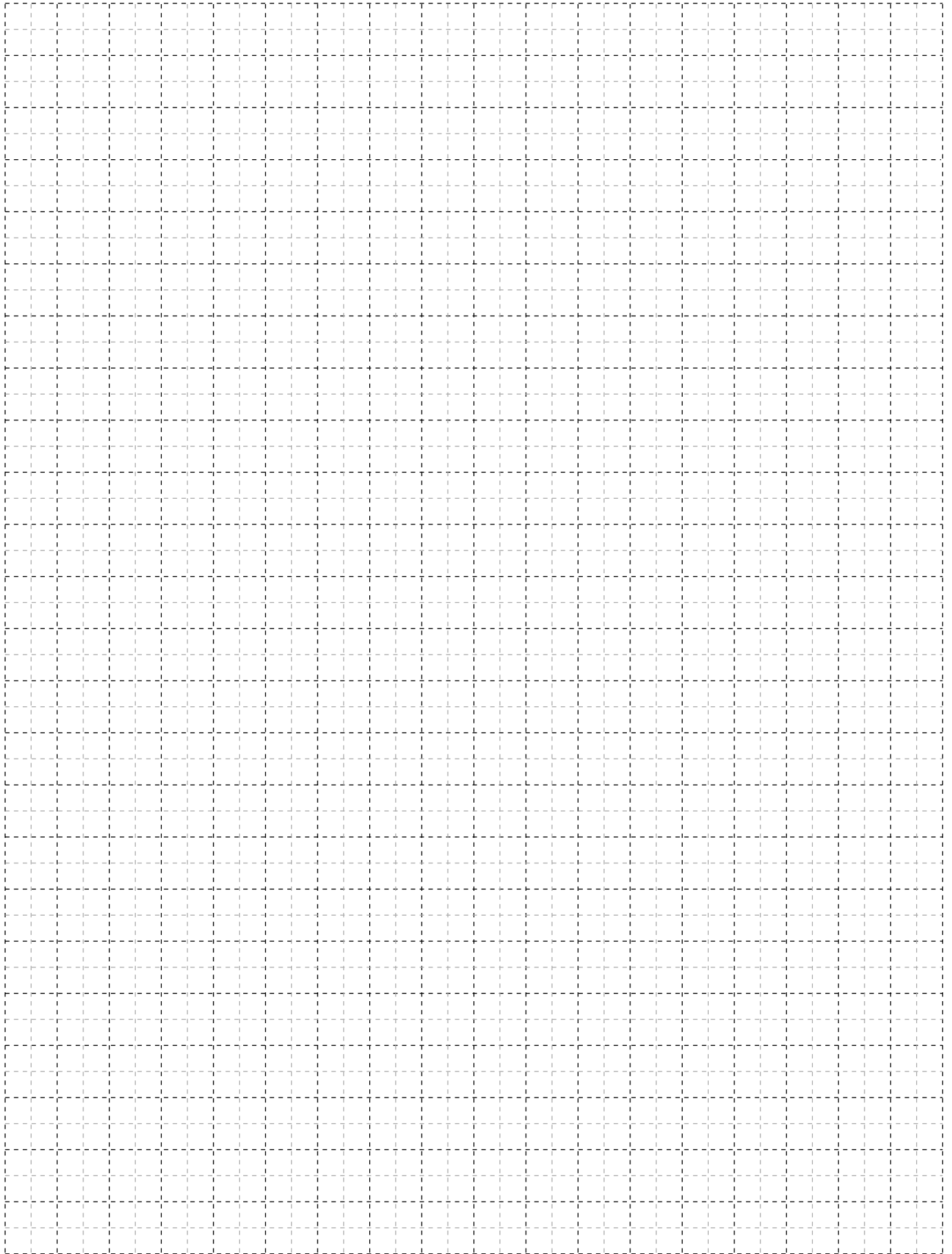

Presjeci 1:1
Sections 1:1

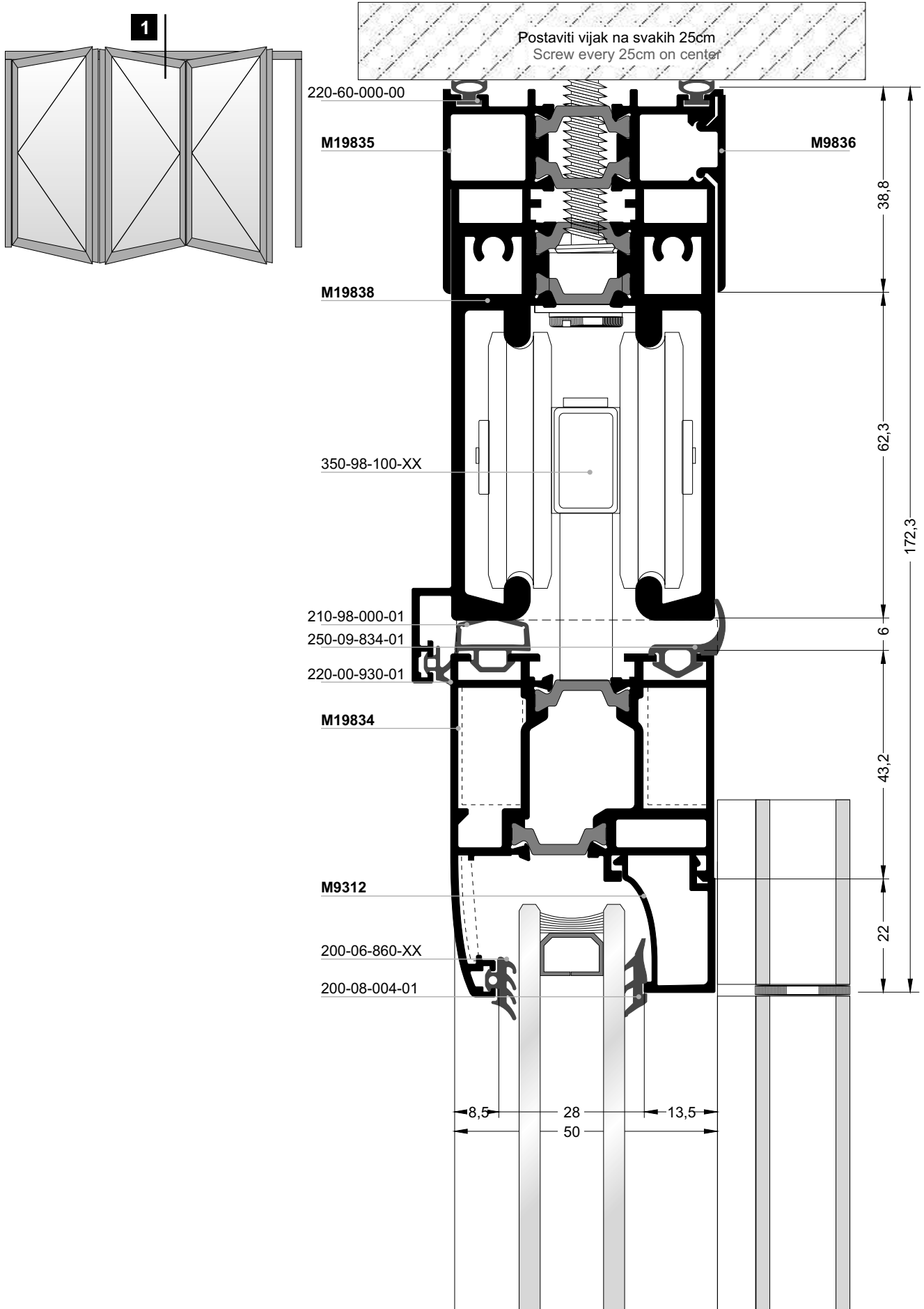

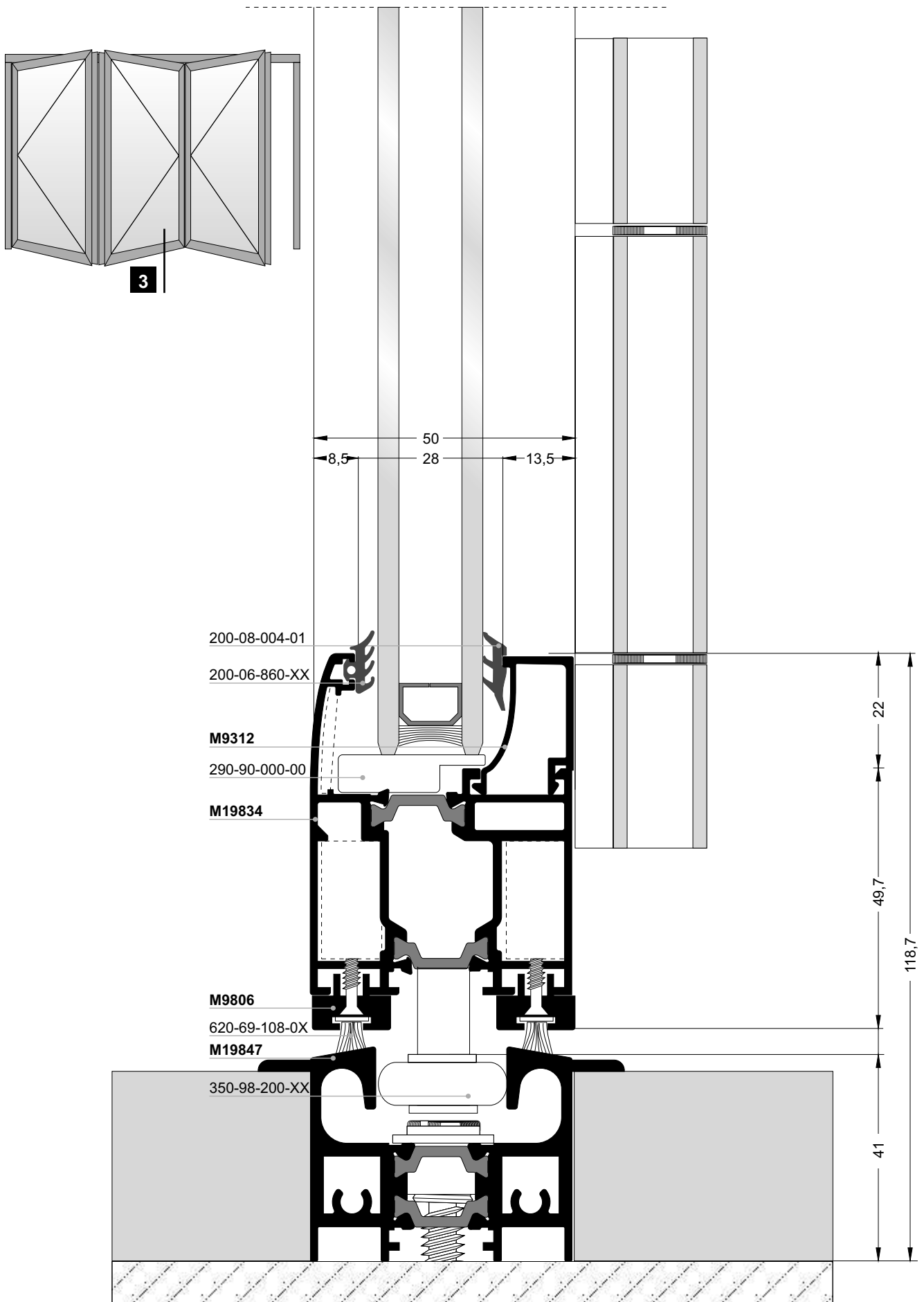

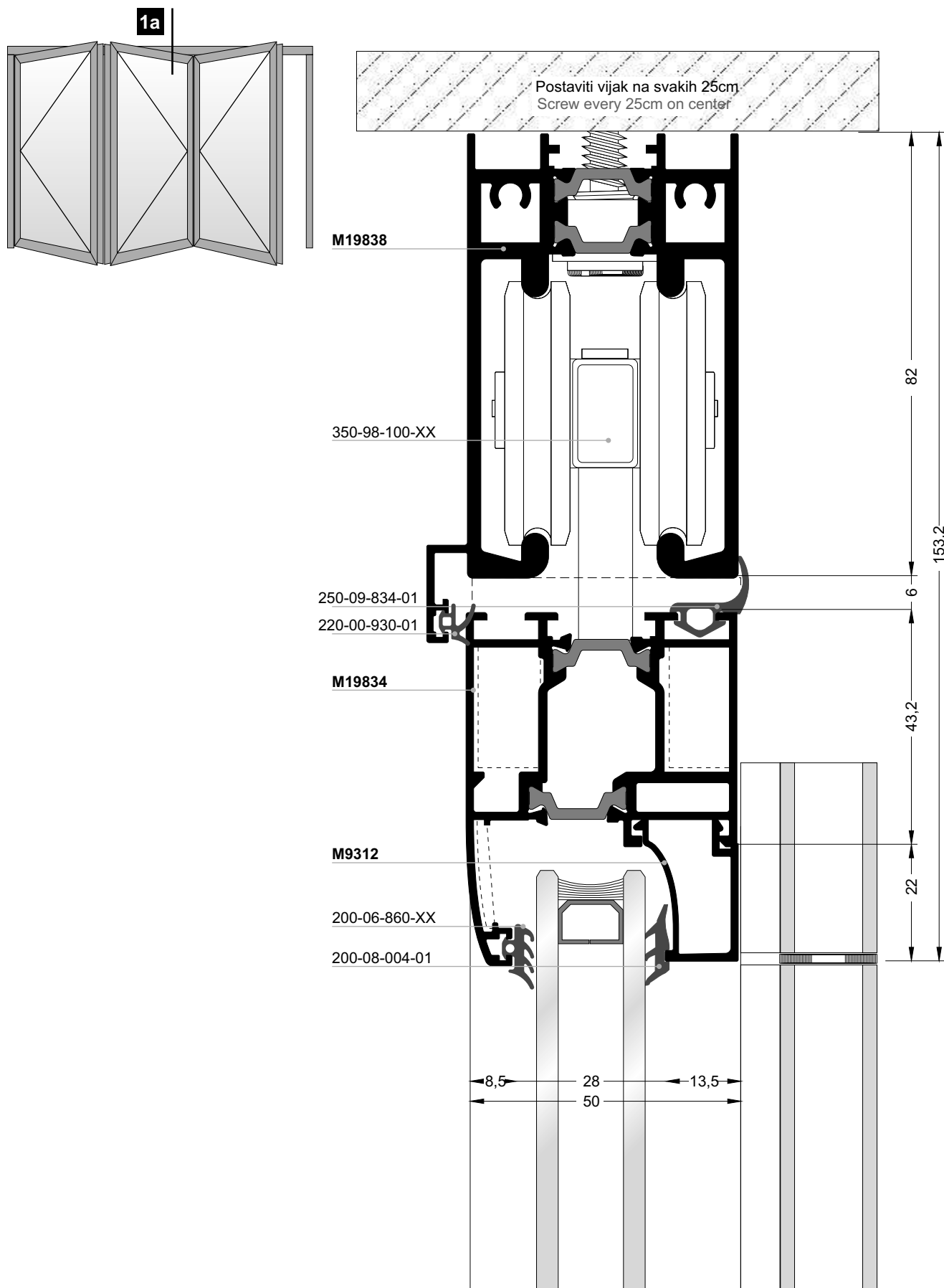

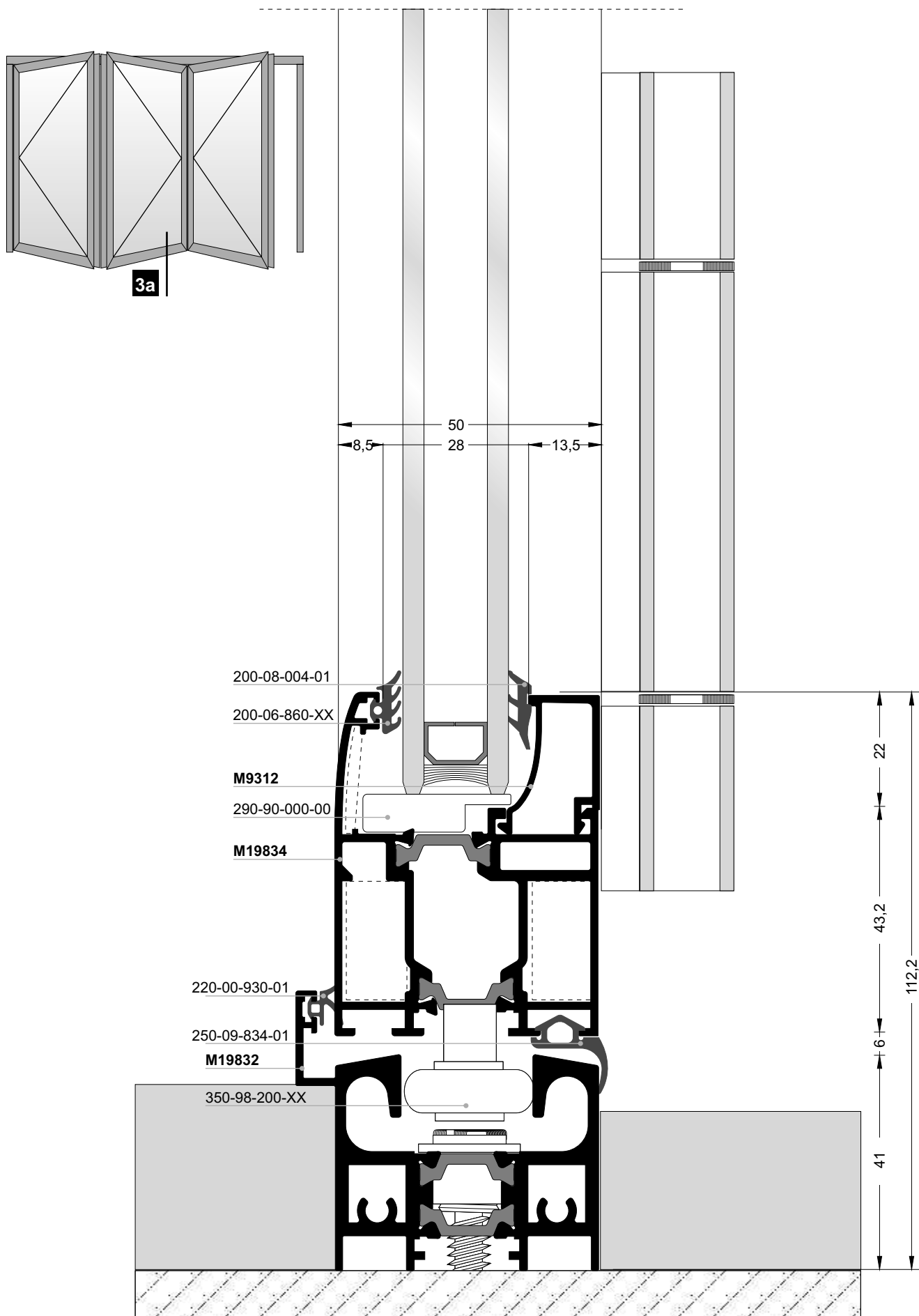

2,2a

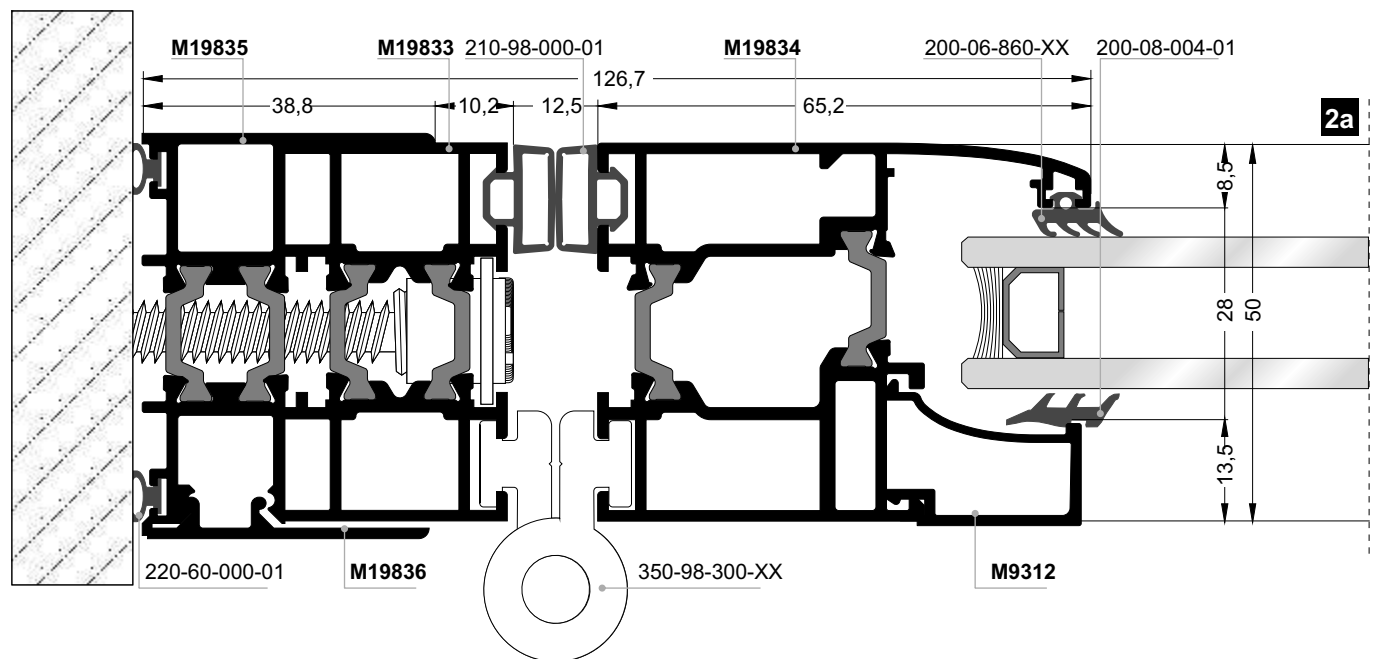
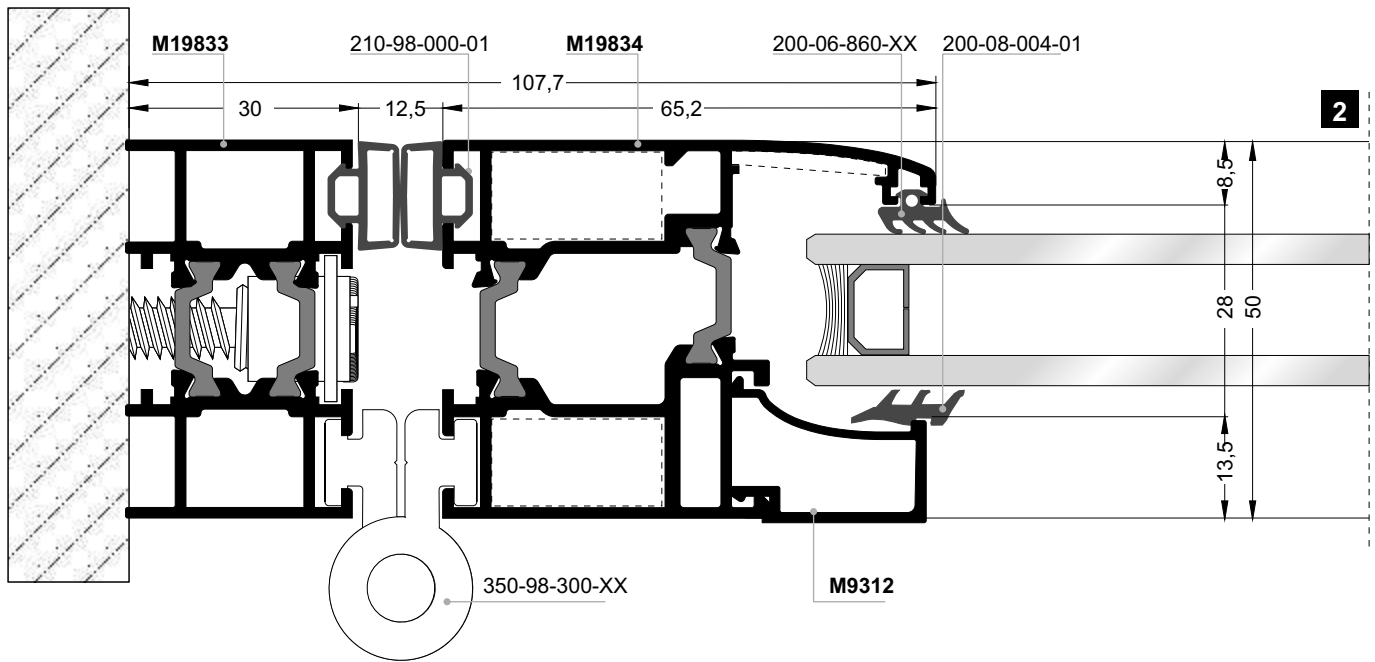
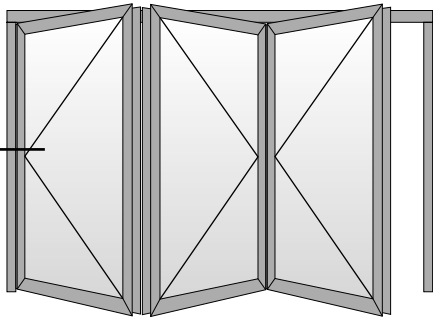

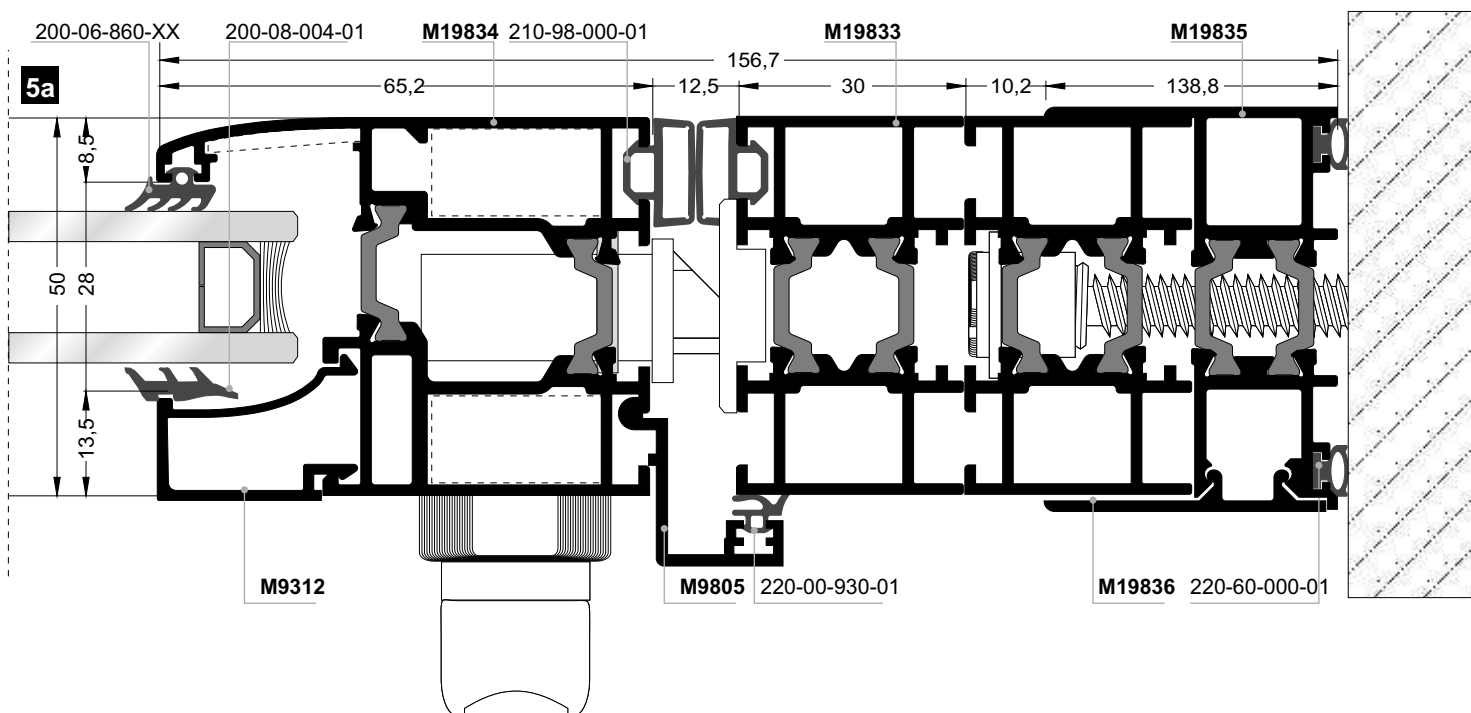
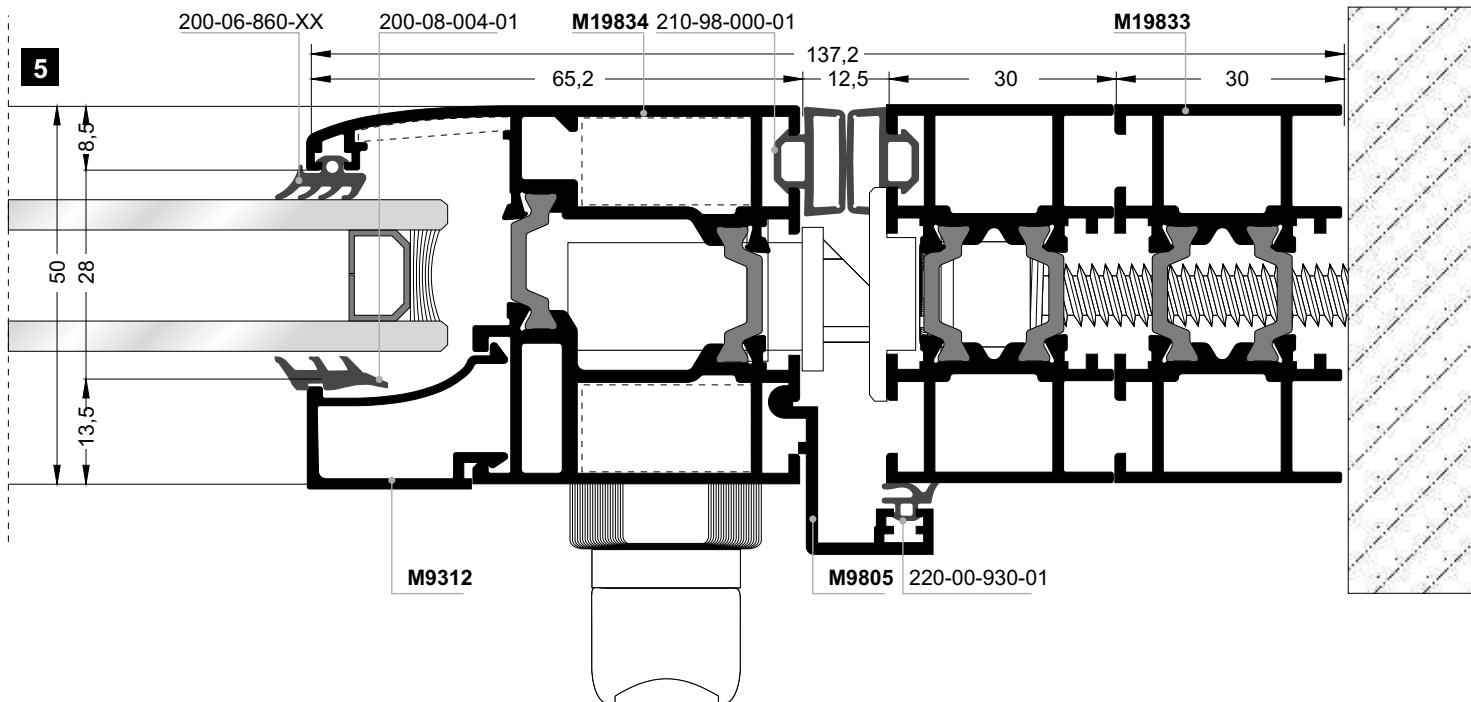
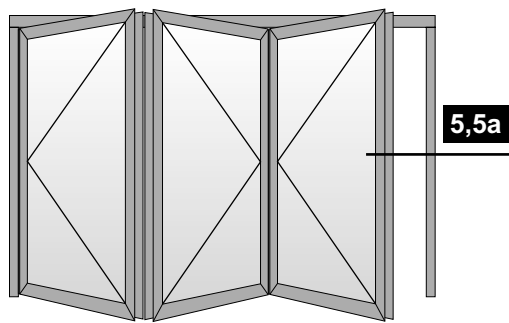

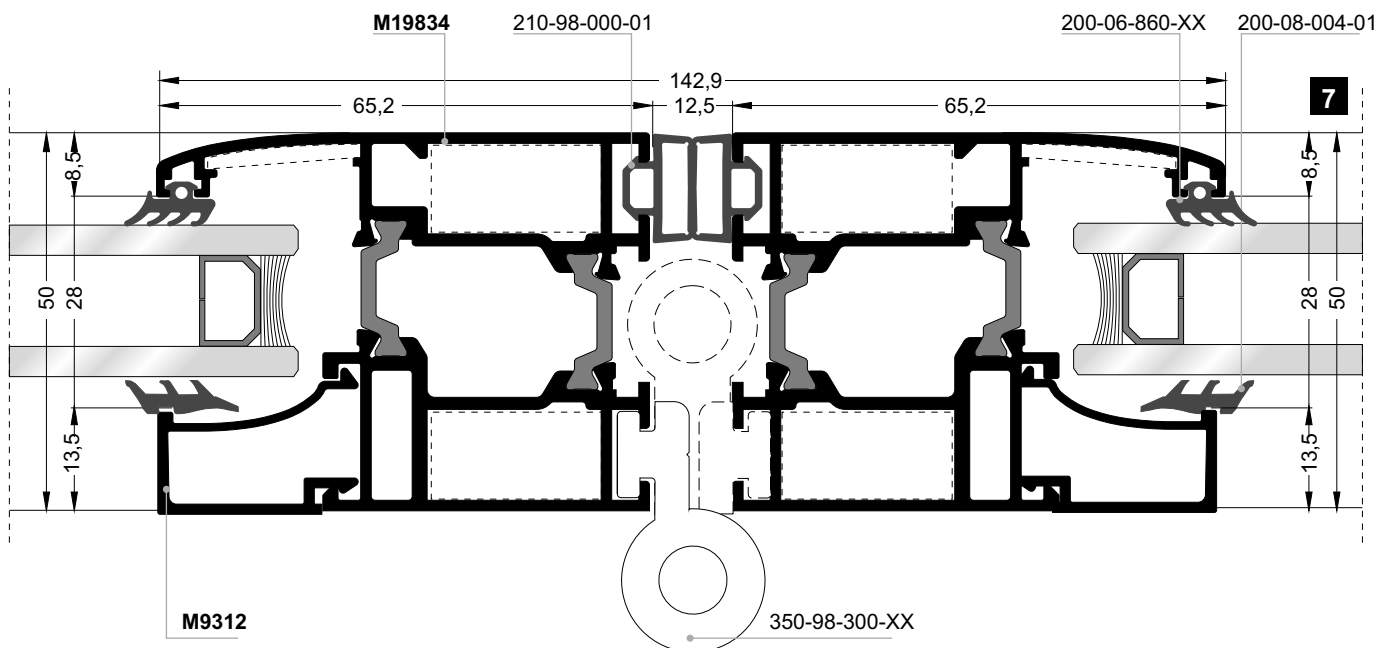
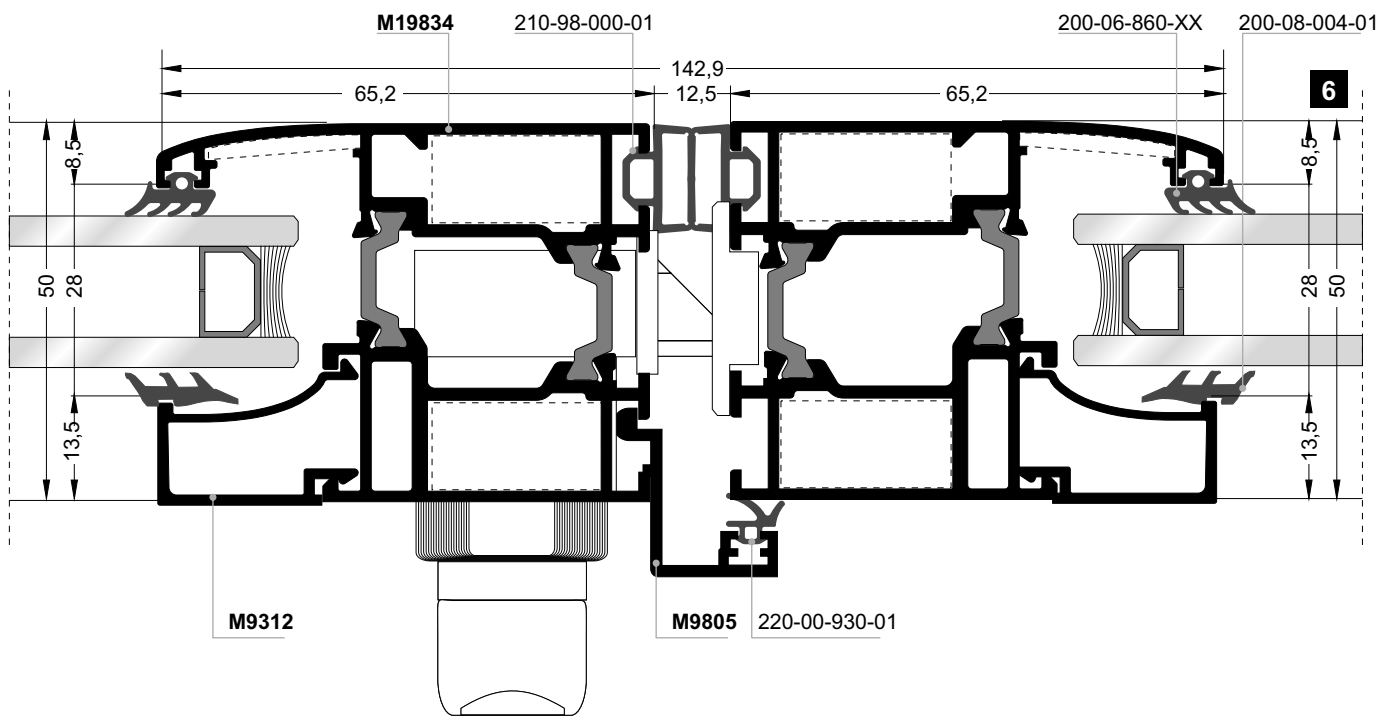
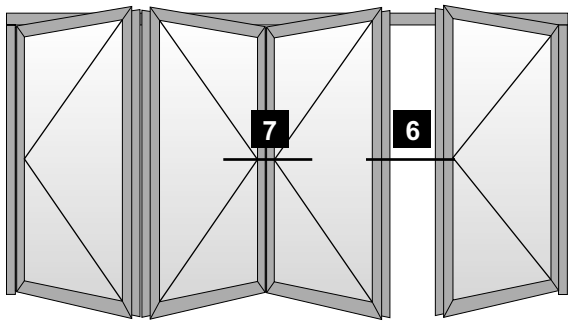

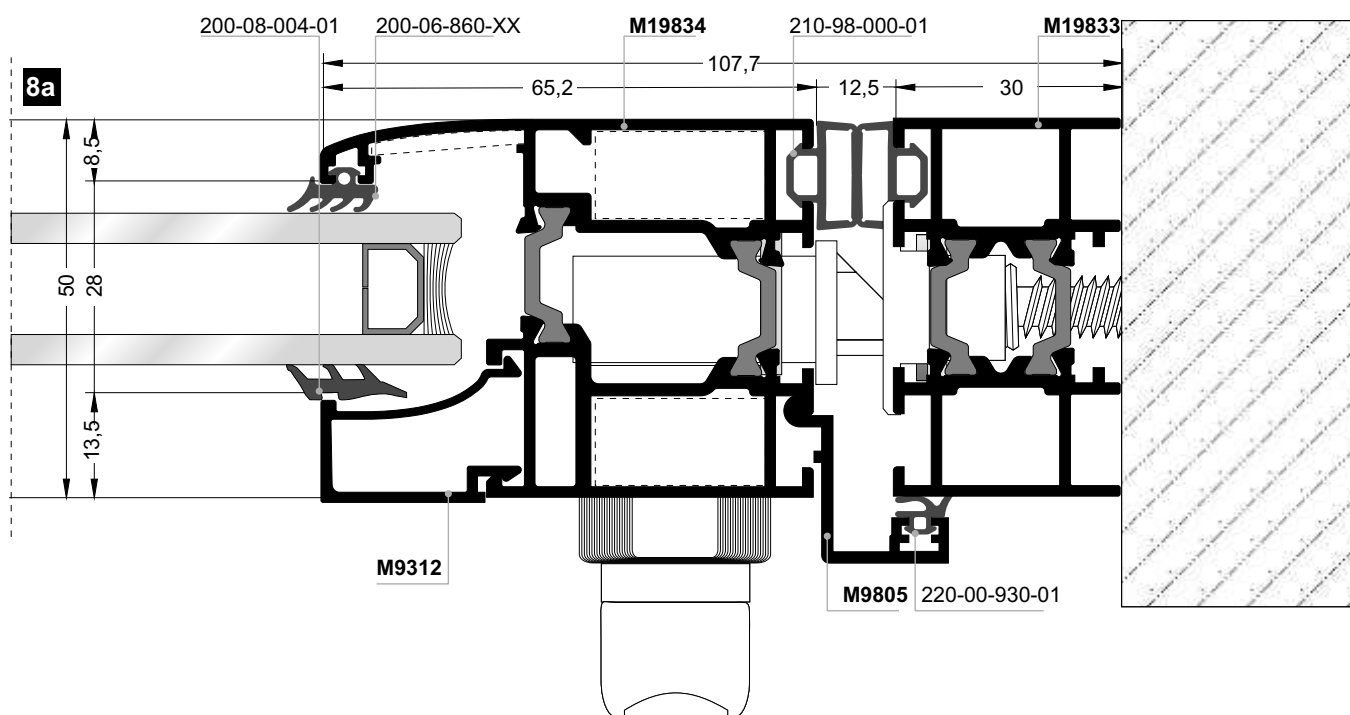
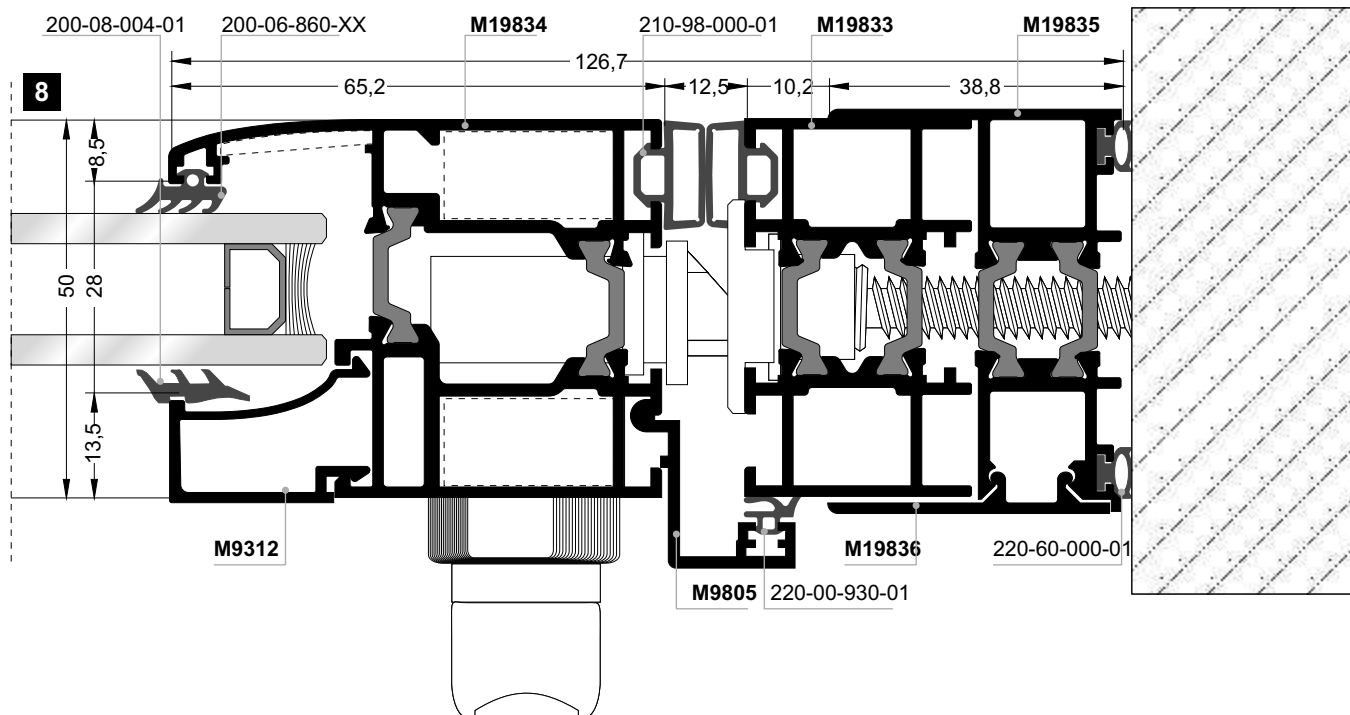
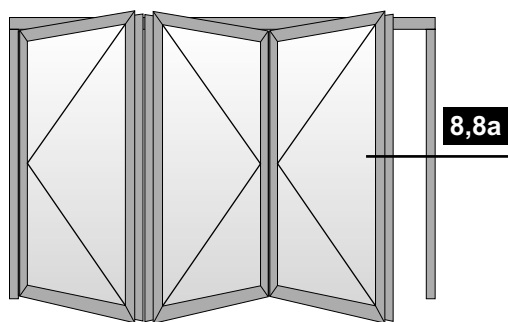

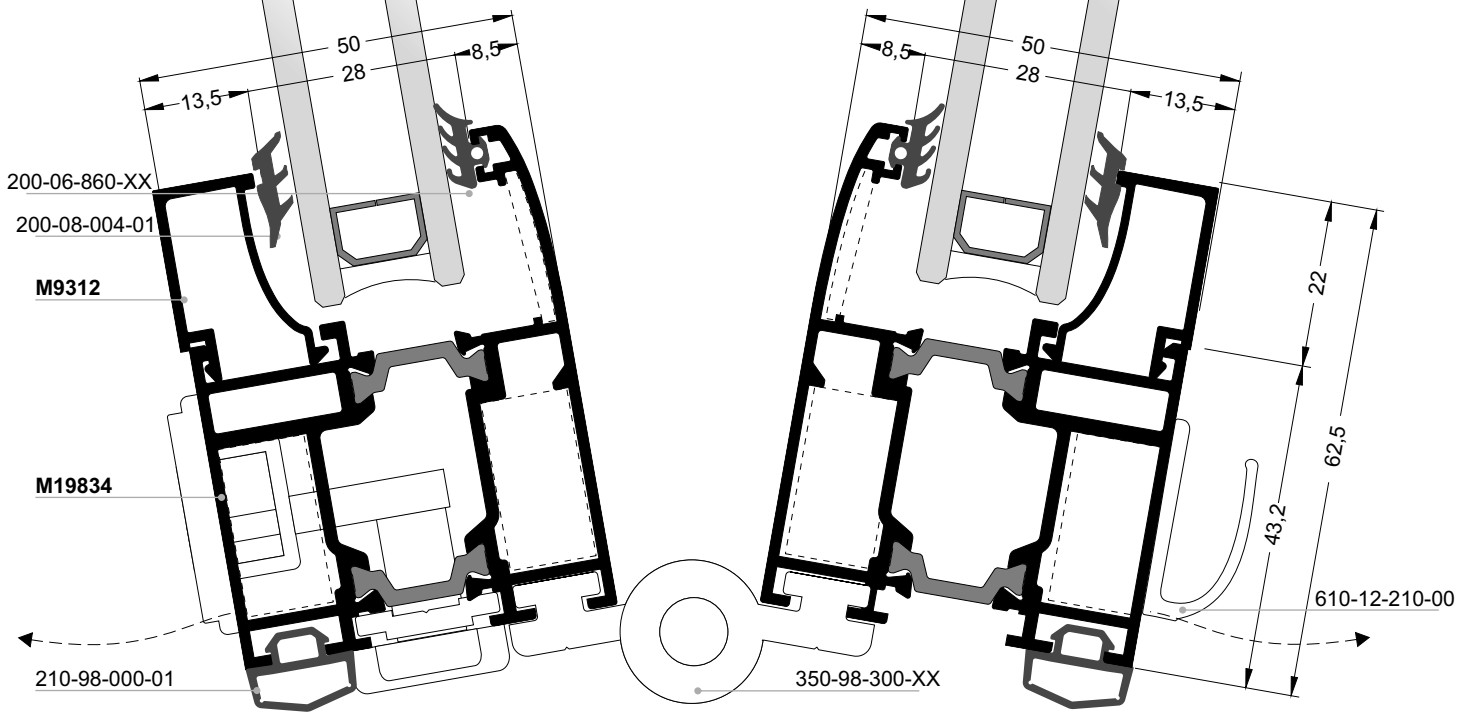
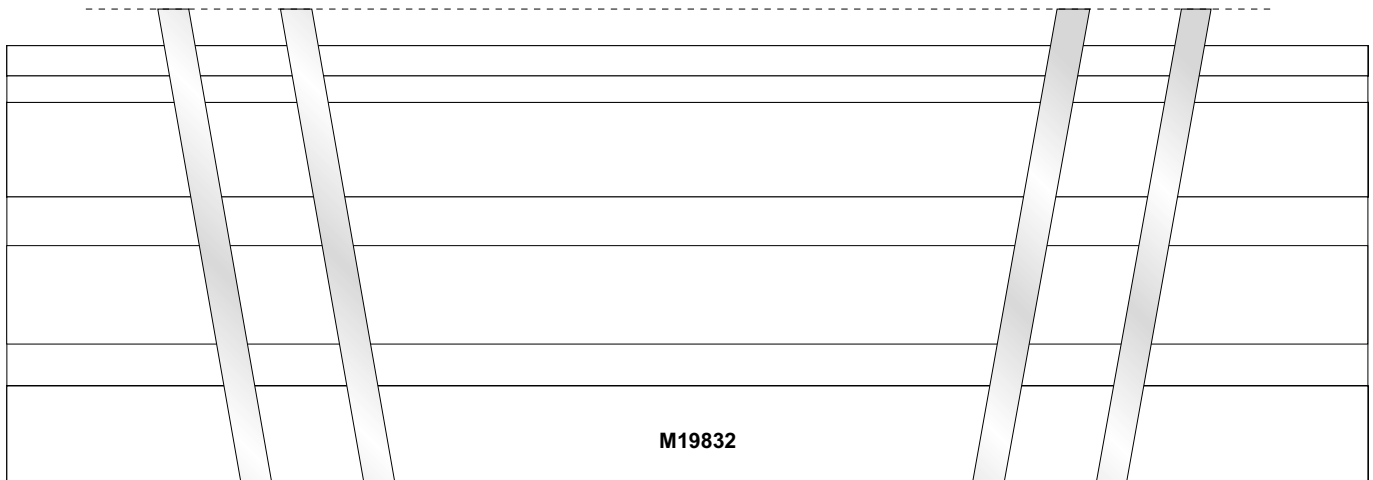
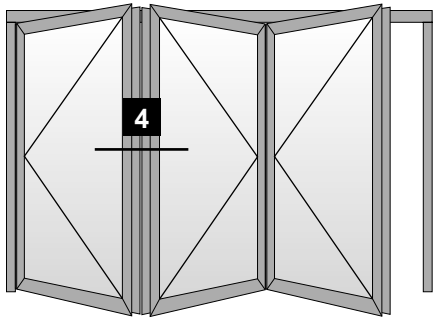

Detalji Details



610-02-210-00

Ručica sa zabavljanjem
Lock and handle detail

Detail locking device

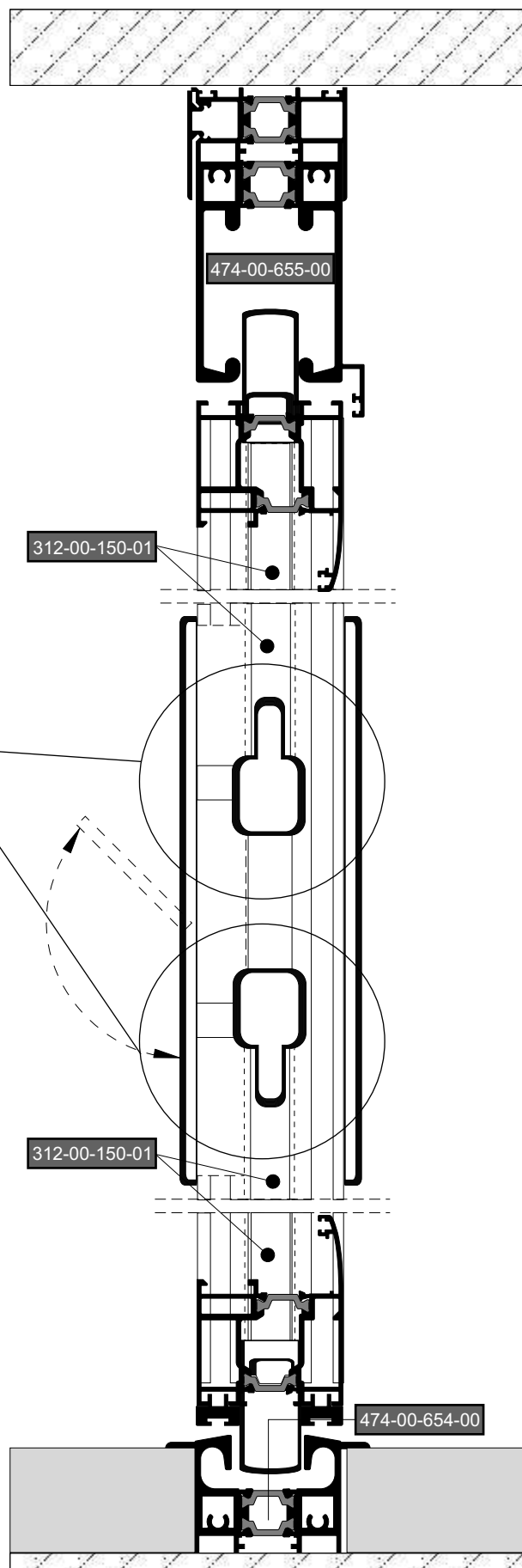

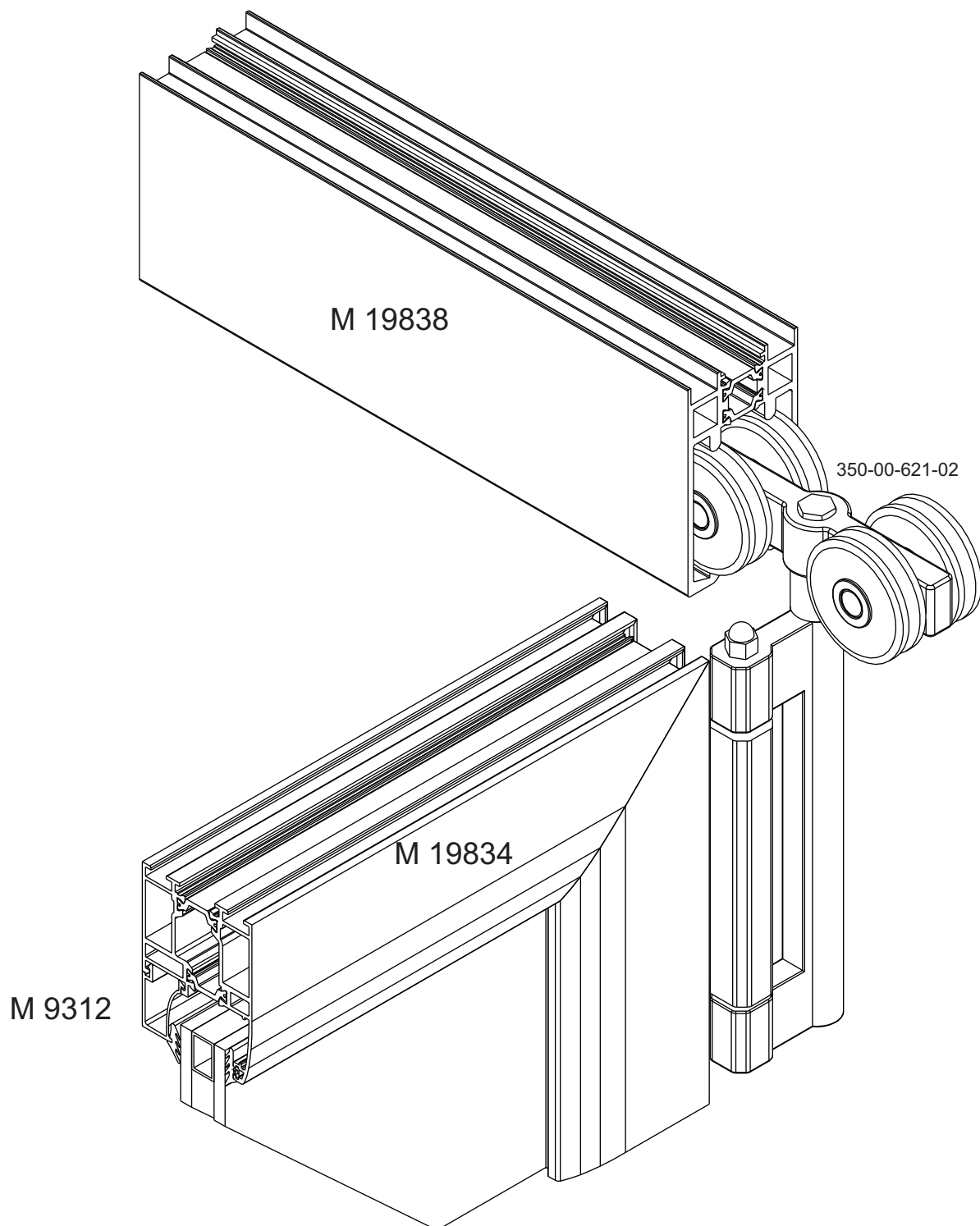
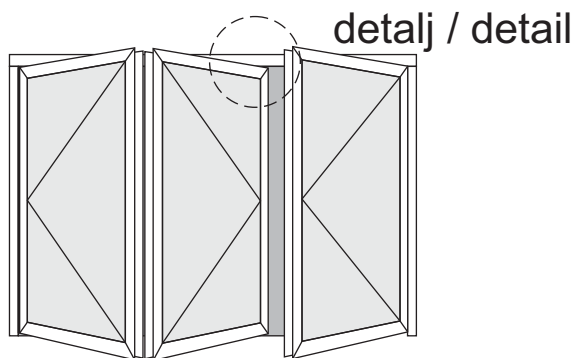

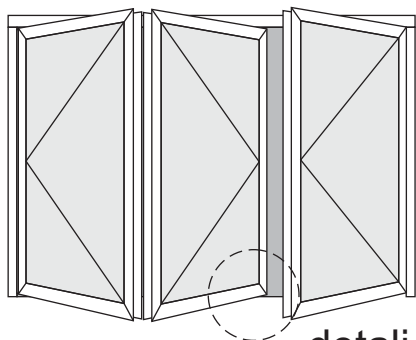

detalj / detail

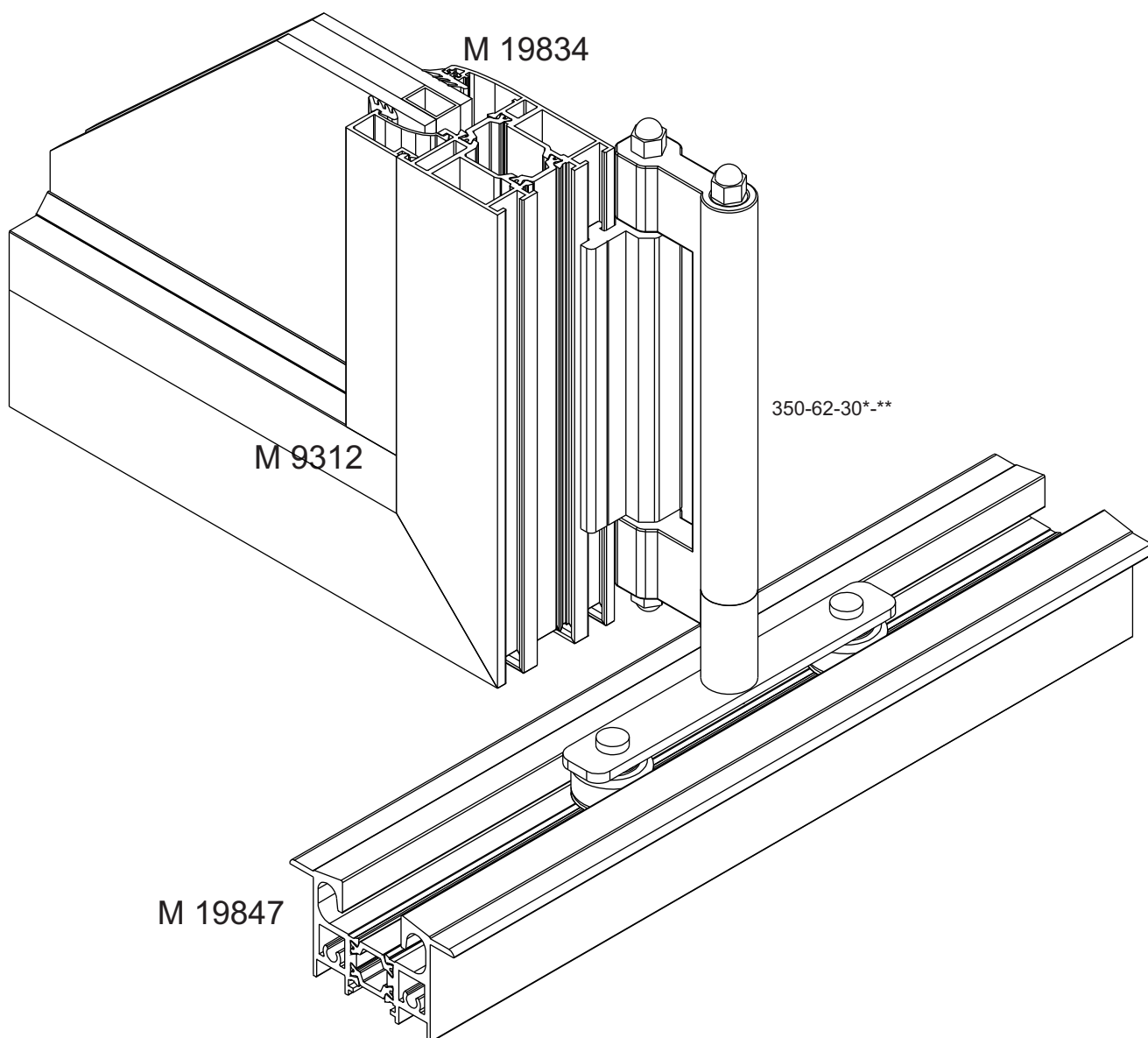

Sječenje Cuttings

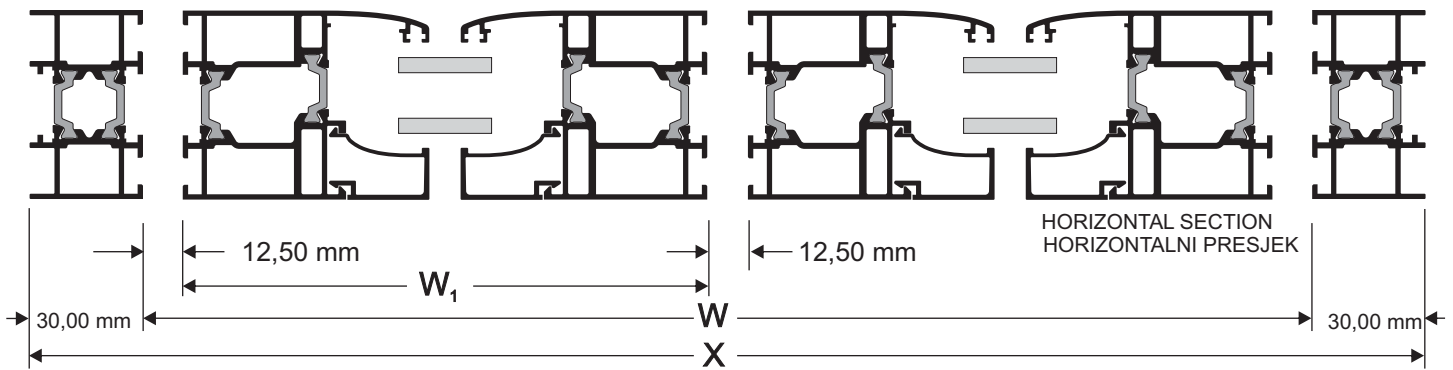

NOTE : ALWAYS CUT THE LAST CASEMENT AFTER MEASURING THE LAST OPENING

NAPOMENA: UVIJEK KROJITE POSLJEDNJE KRILU POSLIJE MJERENJA OSTATKA OTVARAJUĆEG POLJA.

TO CALCULATE THE HEIGHT OF SASH (H_1), MEASURE THE DISTANCE FROM DRIVER INSIDE - INSIDE, (H) AND SUBTRACT 12 mm (6+6).

$$H_1 = H - 12 \text{ mm} \quad \text{or} \quad H_1 = Y - 135 \text{ mm}$$

(HEIGHT SASH)

TO CALCULATE THE WIDTH OF SASH (W_1), FOR INDIVIDUAL LEAVES, MEASURE THE DISTANCE FROM FRAME INSIDE - INSIDE (W), SUBTRACT 12,5 mm TIMES EACH LEAF PLUS ONE, AND DIVIDE BY THE NUMBER OF LEAVES.

$$W = X - 60 \text{ mm}$$

(WIDTH INSIDE)

$$W_1 = \frac{W - (12,5)(N+1)}{N}$$

(WIDTH OF SASH)

EXAMPLE:

FOR FIVE - LEAVES ACCORDION DOOR

(X) = 5 METERS W = 49,4 METERS
(Y) = 2,35 METERS H = 2,20 METERS

HEIGHT OF SASH:

$$2200 \text{ mm} - 12 \text{ mm} = 2188 \text{ mm}$$

WIDTH OF SASH:

$$\frac{4940 \text{ mm} - [12,5 * (5 \text{ LEAVES} + 1)]}{5} = \frac{4940 - 12,5 * 6}{5}$$

$$(4940 - 75) / 5 = 4865 / 5 = 973 \text{ mm}$$

WIDTH OF SASH = 973 mm.

COMMENTS:

1) TOP AND BOTTOM DRIVERS, MUST BE SECURELY ANCHORED EVERY 25 cm, ON CENTER.

2) THE VERTICAL FRAME (M 9833) MUST BE SECURELY FASTENED TO WALL, AT TOP AND BOTTOM, AND ADJOINING DRIVERS CUT TO FIT, WITH A MINIMAL GAP BETWEEN VERTICAL AND HORIZONTAL FRAMES.

3) TO CALCULATE THE ESTIMATE WEIGHT OF ALUMINIUM FOR ACCORDION DOOR IN KILOGRAMS, USE THE FOLLOWING FORMULA:

$$\text{ESTIMATE WEIGHT} = 3(X) + 2,3(N)(W_1) + 1,5(Y) + 2,3(N)(H_1)$$

4) TO CALCULATE THE ESTIMATE WEIGHT USING COVER M19835+M9836 USE THE FOLLOWING FORMULA:

$$\text{ESTIMATE WEIGHT} = 3,8(X) + 2,3(N)(W_1) + 3,1(Y) + 2,3(N)(H_1)$$

LEGEND

X = WIDTH OF ROUGH OPENING, IN METERS
W₁ = WIDTH INSIDE IN METERS
Y = HEIGHT OF ROUGH OPENING, IN METERS
H₁ = HEIGHT INSIDE IN METERS
N = NUMBER OF LEAVES

ZA IZRAČUNAVANJE VISINE KRILA (H_1), IZMJERITE UNUTRAŠNJE RASTOJANJE IZMEĐU VOĐICA (H), I ODUZETI 12mm (6+6).

$$H_1 = H - 12 \text{ mm} \quad \text{ili} \quad H_1 = Y - 135 \text{ mm}$$

(VISINA KRILA)

ZA IZRAČUNAVANJE ŠIRINE KRILA (W_1), ZA POJEDINAČNO KRILU, IZMJERITI UNUTRAŠNJE RASTOJANJE IZMEĐU ŠTOKOVA (W), A ZATIM ODUZETI 12,5mm ONOLIKO PUTA KOLIKO KRILA IMA PLUS JEDAN, I PODIJELITI SABROJEM KRILA.

$$W = X - 60 \text{ mm.}$$

(UNUTRAŠNJA ŠIRINA)

$$W_1 = \frac{W - (12,5)(N+1)}{N}$$

(ŠIRINA KRILA)

PRIMJER:

PETOKRILNA HARMONIKA VRATA

(X) = 5 METARA W = 49,4 METARA
(Y) = 2,35 METARA H = 2,20 METARA

VISINA KRILA:

$$2200 \text{ mm} - 12 \text{ mm} = 2188 \text{ mm}$$

ŠIRINA KRILA:

$$\frac{4940 \text{ mm} - [12,5 * (5 \text{ KRILA} + 1)]}{5} = \frac{4940 - 12,5 * 6}{5}$$

$$(4940 - 75) / 5 = 4865 / 5 = 973 \text{ mm}$$

ŠIRINA KRILA = 973 mm.

KOMENTAR:

1) GORNJA I DONJA VOĐICA, MORAJU BITI FIKSIRANE NA SVAKIH 25 cm, U SREDINI.

2) VERTIKALNI ŠTOK (M 19833) MORABI BITI PRIČVRŠĆE UZ ZID, NA VRHU I U DNU, A PRIHVATNI PROFIL MORA BITI ODSJEČEN SA MINIMALNIM RASTOJANJEM IZMEĐU VERTIKALNOG I HORIZONTALNOG ŠTOKA.

3) ZA IZRAČUNAVANJE Približne težine ALUMINIJUMSKIH PROFILA ZA HARMONIKA VRATA U KILOGRAMIMA, KORISTITE SLJEDEĆU FORMULU:

$$\text{PRIBLIŽNA TEŽINA} = 3(X) + 2,3(N)(W_1) + 1,5(Y) + 2,3(N)(H_1)$$

4) ZA IZRAČUNAVANJE Približne težine KADA SE KORISTE PROFILI M19835+M9836 KORISTI SE SLJEDEĆA FORMULA:

$$\text{PRIBLIŽNA TEŽINA} = 3,8(X) + 2,3(N)(W_1) + 3,1(Y) + 2,3(N)(H_1)$$

LEGENDA:

X = ŠIRINA OTVORA U METRIMA
W₁ = UNUTRAŠNJA ŠIRINA U METRIMA
Y = VISINA OTVORA U METRIMA
H₁ = UNUTRAŠNJA VISINA U METRIMA
N = BROJ KRILA

VERTICAL SECTION
VERTIKALNI PRESJEK

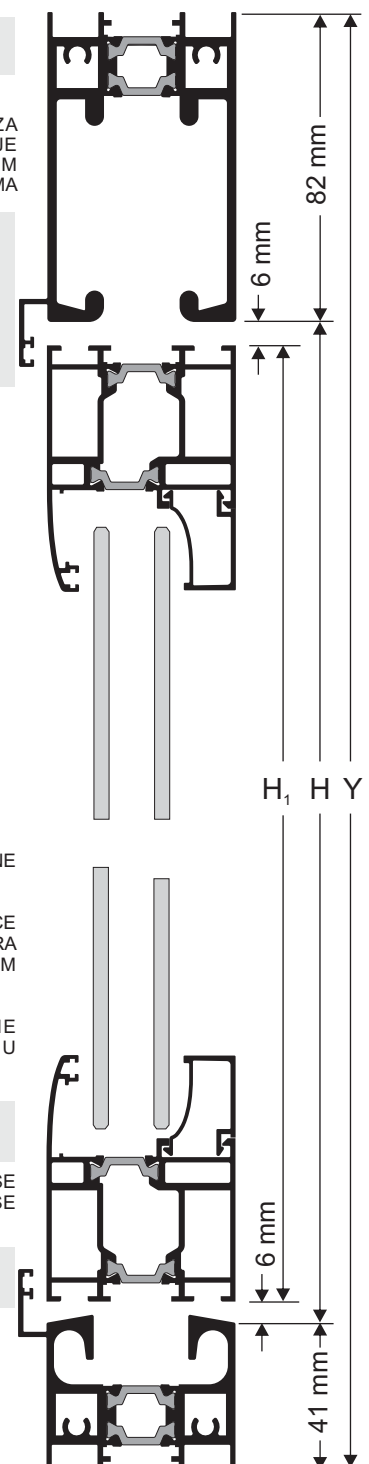

TROKRILNA VRATA THREEFOLDING DOOR (3 LEAVES)

VISINA KRILA HEIGHT OF SASH

$$H_1 = H - 12 \text{ mm}$$

$$H_1 = Y - 135 \text{ mm}$$

ŠIRINA KRILA WIDTH OF SASH

$$W_1 = \frac{W - 50,0 \text{ mm}}{3}$$

$$W_1 = \frac{X - 110,0 \text{ mm}}{3}$$

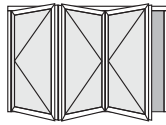

ŠESTOKRILNA VRATA SIXFOLDING DOOR (6 LEAVES)

VISINA KRILA HEIGHT OF SASH

$$H_1 = H - 12 \text{ mm}$$

$$H_1 = Y - 135 \text{ mm}$$

ŠIRINA KRILA WIDTH OF SASH

$$W_1 = \frac{W - 87,5 \text{ mm}}{6}$$

$$W_1 = \frac{X - 147,5 \text{ mm}}{6}$$

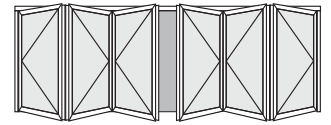

ČETVEROKRILNA VRATA FOURFOLDING DOOR (4 LEAVES)

VISINA KRILA HEIGHT OF SASH

$$H_1 = H - 12 \text{ mm}$$

$$H_1 = Y - 135 \text{ mm}$$

ŠIRINA KRILA WIDTH OF SASH

$$W_1 = \frac{W - 62,5 \text{ mm}}{4}$$

$$W_1 = \frac{X - 122,5 \text{ mm}}{4}$$

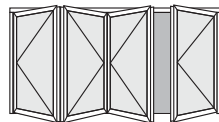

SEDMOKRILNA VRATA SEVENFOLDING DOOR (7 LEAVES)

VISINA KRILA HEIGHT OF SASH

$$H_1 = H - 12 \text{ mm}$$

$$H_1 = Y - 135 \text{ mm}$$

ŠIRINA KRILA WIDTH OF SASH

$$W_1 = \frac{W - 100,0 \text{ mm}}{7}$$

$$W_1 = \frac{X - 160,0 \text{ mm}}{7}$$

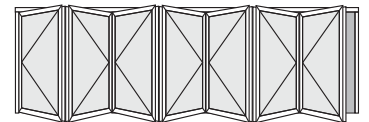

PETOKRILNA VRATA FIVEFOLDING DOOR (5 LEAVES)

VISINA KRILA HEIGHT OF SASH

$$H_1 = H - 12 \text{ mm}$$

$$H_1 = Y - 135 \text{ mm}$$

ŠIRINA KRILA WIDTH OF SASH

$$W_1 = \frac{W - 75,0 \text{ mm}}{5}$$

$$W_1 = \frac{X - 135,0 \text{ mm}}{5}$$

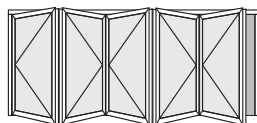

OSMOKRILNA VRATA EIGHTFOLDING DOOR (8 LEAVES)

VISINA KRILA HEIGHT OF SASH

$$H_1 = H - 12 \text{ mm}$$

$$H_1 = Y - 135 \text{ mm}$$

ŠIRINA KRILA WIDTH OF SASH

$$W_1 = \frac{W - 112,5 \text{ mm}}{8}$$

$$W_1 = \frac{X - 172,5 \text{ mm}}{8}$$

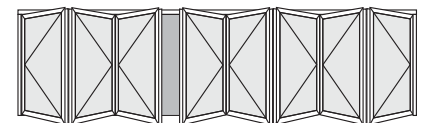

LEGENDA ZA INSTRUKCIJE ZA SJEČENJE

X = ŠIRINA POZICIJE U MILIMETRIMA
 W₁ = UNUTRAŠNJA ŠIRINA MILIMETRIMA
 Y = VISINA POZICIJE U MILIMETRIMA
 H₁ = UNUTRAŠNJA VISINA U MILIMETRIMA

LEGEND FOR CUTTING INSTRUCTIONS

X = WIDTH OF ROUGH OPENING IN MILLIMETERS
 W₁ = WIDTH INSIDE IN MILLIMETERS
 Y = HEIGHT OF ROUGH OPENING IN MILLIMETERS
 H₁ = HEIGHT INSIDE IN MILLIMETERS

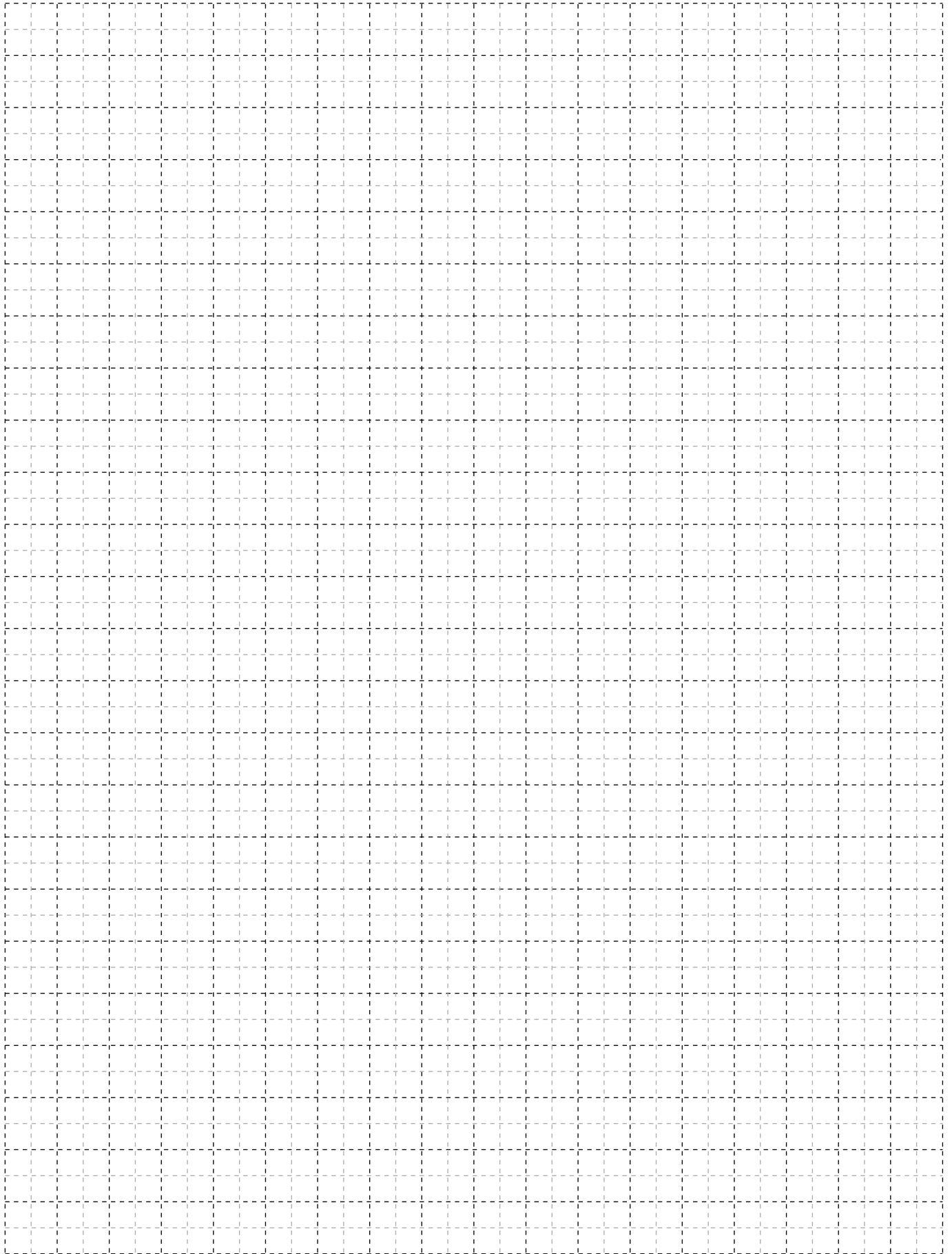

Pribori - Zaptivke
Accessories - Gaskets

113-23-121-00

Aluminijum|Aluminium Komad|Piece



Kruta spojnica|Crimp cleat

180-19-834-00

Poliamid crni Komad|Piece
Polyamide Black



Pomoćna spojnica |Alignment corner

480-01-127-01

Set|Set



Set za zavravljivanje|Kit locker

474-00-654-00

Poliamid crni Komad|Piece
Polyamide Black



Zavravljivač
Dead bolt latch for accordion

474-00-655-00

Poliamid crni Komad|Piece
Polyamide Black



Zavravljivač
Dead bolt latch for accordion

350-98-300-02 Bijelo|White
350-98-300-03 Crno|Black
350-98-300-11 Silver|Silver

Aluminijum|Aluminium Komad|Piece



Šarka|Hinge

350-98-100-02 Bijela|White
350-98-100-03 Crna|Black
350-98-100-11 Silver|Silver

Aluminijum|Aluminium Komad|Piece



Točkići sa šarkom
Wheels-hinges for accordion

350-98-400-02 Bijela|White
350-98-400-03 Crna|Black
350-98-400-11 Silver|Silver

Aluminijum|Aluminium Komad|Piece

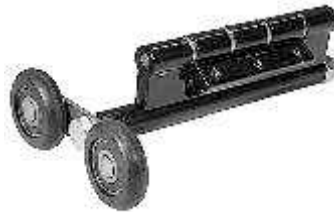

Donji točkići za M9811
Lower hinge for accordion M9811

350-98-200-02 Bijela|White
350-98-200-03 Crna|Black
350-98-200-11 Silver|Silver

Aluminijum|Aluminium Komad|Piece



Točkići sa šarkom
Wheels-hinges for accordion

290-09-000-00

PVC Crna|PVC Black Komad|Piece



Kajla|Setting block

300-09-805-02 Bijela|White
300-09-805-03 Crna|Black

Poliamid|Polyamide Par|Pair



Pokl. za deko. profi.|End cap for prof.

312-00-150-01

Poliamid crni Komad|Piece
Polyamide Black



Letva 3m|Tie rod 3m

610-02-210-02 Bijela|White
610-02-210-03 Crna|Black
610-02-210-09 Silver|Silver

Komad|Piece



Bravica za klizno ALBATROS
Locker for sliding door

610-12-210-00

Aluminijum|Aluminium Komad|Piece



Ručica|Handle

290-00-002-00 (2mm zelena|green)
290-00-003-00 (3mm braon|brown)
290-00-004-00 (4mm crvena|red)
290-00-005-00 (5mm crna|black)

Poliamid|Polyamide Komad|Piece



Kajla |Setting block

610-09-849-02 Bijela|White
610-09-849-03 Crna|Black
610-09-849-09 Silver|Silver

Aluminijum|Aluminium Komad|Piece



Ručica|Handle

311-09-849-00 Crna|Black

Poliamid|Polyamide Par|Pair



Poklopac za 610-09-849-XX
End cap for handle 610-09-849-XX

160-11-213-00

Aluminijum|Aluminium Komad|Piece



Unutrašnja spojnica za T-prečku
Inner transom-mullion cleat

620-03-406-03 (No6) Crna |Black
 620-03-406-04 (No6) Siva|Grey
 620-03-407-03 (No7) Crna |Black
 620-03-407-04 (No7) Siva|Grey

Metar|Meters



Četkica sa membranom
Brush with membrane

200-06-860-01 Crna |Black
 200-06-860-12 Siva|Grey

EPDM |EPDM Metar|Meters



Zaptivka za staklo |Outer glazing ga.

210-98-000-01 Crna |Black

EPDM |EPDM



Zaptivka za harmonika vrata
Gasket for according door

220-00-930-01 Crna |Black

EPDM |EPDM



Zaptivka |Gasket

220-60-000-01

PVC Crna |PVC Black



Zaptivka
Gasket

250-09-834-01 Crna |Black

EPDM |EPDM



Zaptivka za harmonika vrata
Gasket for according door

620-69-104-04 (No4) Siva|Grey
 620-69-105-03 (No5) Crna |Black
 620-69-105-04 (No5) Siva|Grey
 620-69-106-02 (No6) Bijela|White
 620-69-106-03 (No6) Crna |Black
 620-69-106-04 (No6) Siva|Grey
 620-69-107-03 (No7) Crna |Black
 620-69-107-04 (No7) Siva|Grey
 620-69-108-02 (No8) Bijela|White
 620-69-108-03 (No8) Crna |Black
 620-69-108-04 (No8) Siva|Grey
 620-69-100-02 (No10) Bijela|White
 620-69-100-03 (No10) Crna |Black
 620-69-100-04 (No10) Siva|Grey

Metar|Meters



Četkica |Simple brush

200-08-002-01 (2mm) EPDM Crna |Black
 200-00-202-03 (2mm) PVC Crna |Black
 200-08-003-01 (3mm) EPDM Crna |Black
 200-00-203-03 (3mm) PVC Crna |Black
 200-08-004-01 (4mm) EPDM Crna |Black
 200-00-204-03 (4mm) PVC Crna |Black
 200-08-005-01 (5mm) EPDM Crna |Black
 200-00-205-03 (5mm) PVC Crna |Black
 200-08-006-01 (6mm) EPDM Crna |Black
 200-00-206-03 (6mm) PVC Crna |Black
 200-08-007-01 (7mm) EPDM Crna |Black
 200-00-207-03 (7mm) PVC Crna |Black
 200-08-008-01 (8mm) EPDM Crna |Black
 200-00-208-03 (8mm) PVC Crna |Black
 200-08-010-01 (10mm) EPDM Crna |Black
 200-00-210-03 (10mm) PVC Crna |Black

Metar|Meters



Zaptivka za staklo |Inner glaz. gas.

Opšte informacije General Information

1. AUTORSKA PRAVA

Alumil S.A. zadržava sva prava. Nijedan dio ovog uputstva kao informacije date u njemu, ne mogu se koristiti bez pismenog odobrenja Alumil grupacije. Takođe, nije dozvoljeno umnožavanje, distribucija, publikovanje, cijelog uputstva ili njegovog dijela, u bilo kojoj formi (fizički u elektronskoj formi, štampane kopije, fotokopiran), bez pismenog odobrenja Alumil grupacije.

2. ODGOVORNOST

U izradi ovog uputstva učinjeni su maksimalni naponi da informacije u njemu budu aktuelne, tačne i jasno prezentovane. Postoji mogućnost pojave nenamjernih i slučajnih grešaka u informacijama. Alumil ne preuzima odgovornost za nenamjerne greške i greške u kucanju, bez obzira na učinjene napore na njihovom eliminisanju. Kada se uvidi potreba za mjenjanjem informacija u ovom uputstvu, Alumil će to učiniti bez obaveze pribavljanja saglasnosti korisnika uputstva. Alumil i njegovi autorizovani predstavnici i dileri ne daju nikakvu garanciju ili obećanje u vezi kvaliteta, sadržaja, kompletnosti, podobnosti, adekvatnosti, presjeka, tačnosti i trajanja informacija sadržanih u ovom uputstvu.

3. OPŠTE INFORMACIJE

3.1. Aluminijum kao materijal

Aluminijum je pogodan za ekstruziju složenih oblika sa uskom tolerancijom, i moguće ga je oblikovati u hiljade različitih oblika profila. Ova karakteristika omogućuje njegovu upotrebu u kontekstu specifičnih strukturnih i estetskih zahtjeva. Upotrebom aluminijumskih profila omogućuju se jednostavna i elegantna rješenja za veoma kompleksne probleme u projektovanju, koja imaju veoma dug rok eksploatacije zbog njegovih karakteristika. Aluminijum se koristi za vanjsku upotrebu zbog njegove čvrstoće, postojanosti na koroziju i niske specifične mase. Jedna od glavnih prednosti aluminijuma kao materijala je odličan odnos između njegove čvrstoće i težine. Sa 2,7 g/cm³, aluminijum je 66% lakši nego čelik. Takođe, on je daleko manje podložan lomljenju u poređenju sa čelikom. Kada se poredе konstrukcije izrađene od aluminijuma sa konstrukcijama izrađenim od čelika, aluminijum ima veći modul elastičnosti, što znači da se uz odnos težina 1:2 postiže isti modul. Aluminijum je moguće obrađivati na mašinama koje rade na velikim brzinama i nisu potrebna zavarivanja spojeva, što direktno utiče na brzinu u proizvodnji. Za građevinske profile Alumil koristi leguru EN AW 6060 u skladu sa EN 755-1. Mehaničke karakteristike zadovoljavaju standard EN 755-2, sa modulom elastičnosti 70GPa. Tolerancije su u skladu sa EN 755-3.

3.2. Kontakt sa drugim materijalima

3.2.1. Metal

Kada dva metala, sa različitim neelektrisanjem u vlažnim uslovima dođu u kontakt, formira se elektro par što za rezultat ima stvaranje oksida, uz trošenje metala sa negativnim naelektrisanjem. Kako bi izbjegli ove efekte neophodno je postaviti izolacionu barijeru između dva metala. Kontakt sa galvanizovanim čelikom nije štetan za aluminijum. Kontakt sa bakrom i legurama bakra je izuzetno štetan za aluminijum. Obavezno se mora spriječiti kontakt aluminijuma i bakra. I kontakt sa olovom mora biti spriječen.

3.2.2. Drvo

Generalno, drvo nema negativan uticaj na aluminijum. Neke vrste drveta, kao što je orah, proizvode kiselinu koja nagrizava aluminijum. Do ove pojave dolazi posebno u vlažnom okruženju ili kada drvo nije dovoljno osušeno. Preporučljivo je izolaciju uraditi premazivanjem drveta bitumenskim bojama. Kada se drvo tretira hemikalijama za zaštitu od vlage i insekata potrebno je provjeriti hemijski sastav sredstva (Da li postoje hemikalije koje oštećuju aluminijum?). Proizvodi koji sadrže soli bakra, živine soli i flouridna jedinjenja su veoma štetni za aluminijum.

3.2.3. Kreč i cement

U vlažnim uslovima, kreč i cement reaguju sa aluminijumom (čak i kad je anodiziran) ostavljajući bijele tačke na profilu i nakon čišćenja. Poželjno je zaštititi aluminijum tokom instalacije sa Alumil zaštitnom folijom.

3.3. Površinska zaštita

Za profile obezbjeđujemo sljedeće boje:

Anodizacija: nijanse od prirodne boje aluminijuma pa do tamno braon boje.

Proces anodizacije je usklađen sa EWAA-EURAS i QUALANOD regulativom.

Plastifikacija: nijanse po RAL karti.

Plastifikacija je usklađena sa QUALICOAT regulativom.

3.4. Skladištenje

Kako bi se izbjegla površinska oštećenja potrebno je preduzeti sljedeće mjere:

- Profile skladištiti u suvom prostoru.
- Izbjegavati svaki kontakt sa čelikom štiteći profile sa papirom za pakovanje ili plastičnom folijom. U vlažnim uslovima rđa i čelik mogu oštetiti površinu profila.
- Profile skladištiti horizontalno tako da se eliminiše mogućnost oštećenja ili grebanja profila tokom njegovog pomjeranja.
- Profile skladištiti na regale.

3.5. Održavanje aluminijuma

I anodizirani i plastificirani profili treba da se redovno čiste i održavaju. U seoskim područjima, gdje profili nisu izloženi agresivnim elementima (zagađen vazduh, slan vazduh), aluminijumske profile treba čistiti kada se čiste i stakla. Mlaka voda bez agresivnih deterdženata, bez kiselih deterdženata i bez amonijaka je dovoljna za čišćenje. Nakon čišćenja, potrebno je aluminijum isprati čistom vodom i posušiti tkaninom. U gradskim područjima i u primorju, aluminijum je neophodno čistiti češće i detaljnije. Područja koja nisu izložena kiši potrebno je čistiti češće. Kada mlaka voda i blagi deterdžent nisu dovoljni za otklanjanje nečistoća, potrebno je koristiti deterdžente koji su posebno namijenjeni za aluminijum. Ovi deterdženti imaju u sebi lake abrazivne materijale i mogu se koristiti u kombinaciji sa sintetičkim tkaninama. U svakom slučaju je neophodno je isprati površinu sa čistom vodom i pažljivo posušiti, posebno uglove i donje profile. Imajući u vidu potrebu za zaštitom proizvoda i produženjem njegovog životnog vijeka, potrebno ga je tretirati sa veoma tankim čistim tekstilom.

	Evropski standardi i referentni materijali	European standards and reference material
EN 10211	Termički mostovi u garđevinskim konstrukcijama - Toplotni tokovi i površinske temperature - Detalji kalkulacije (ISO10211:2007) Dio 1-2	
EN 12020-1	Aluminijum i legure aluminijuma - Ekstrudirani precizni profili od legura EN AW-6060 i EN AW-6063 - dio 1 Tehnički uslovi za kontrolu i isporuku	
EN 12020-2	Aluminijum i legure aluminijuma - Ekstrudirani precizni profili od legura EN AW-6060 i EN AW-6063 - dio 2 Tolerancije oblika i mjera	
EN 12046	Radne sile - Metodi testiranja - Dio 1: Prozori Dio 2: Vrata	
EN 12152	Ovještene fasade - Vazdušna propustljivost - Zahtjevi po pitanju karakteristika i klasifikacija	
EN 12153	Ovještene fasade - Vazdušna propustljivost - Metode testiranja	
EN 12154	Ovještene fasade - Vodonepropustnost - Zahtjevi po pitanju karakteristika i klasifikacija	
EN 12155	Ovještene fasade - Vodonepropustnost - Laboratorijsko testiranje sa statičkim pritiskom	
EN 12179	Ovještene fasade - Otpornost na udar vjetra - Metode testiranja	
EN 12207	Ovještene fasade - Otpornost na udar vjetra - Klasifikacija	
EN 12208	Prozori i vrata - Vodonepropustnost - Klasifikacija	
EN 12210	Prozori i vrata - Otpornost na udar vjetra - Klasifikacija	
EN 12211	Prozori i vrata - Vodonepropustnost - Metode testiranja	
EN 12400	Prozori i pješačka vrata - Mehanička izdržljivost - Zahtjevi i klasifikacija	
EN 12519	Prozori i pješačka vrata - Terminologija	
EN 12567	Termičke performanse prozora i vrata - Određivanje termičke provodljivosti putem metoda tople komore - Dio 1-2	
EN 13049	Prozori - Udar čvrstih i elastičnih tijela - Metode testiranja, zahtjevi bezbjednosti i klasifikacija	
EN 13115	Prozori - Klasifikacija mehaničkih osobina - Istezanje, uvijanje i operativne sile	
EN 13141	Ventilacija za objekte - Testiranje karakteristika dijelova/proizvoda za stambene objekte Dio 1-8	
EN 13123	Prozori, vrata i roletne - otpornost na eksplozije - Zahtjevi i klasifikacija Dio 1-2	
EN 13124	Prozori, vrata i roletne - otpornost na eksplozije - Metode testiranja Dio 1-2	
ENV 13420	Prozori - Ponašanje kod različitih klima - Metode testiranja	
EN 13501	Požarna klasifikacija građevinskih proizvoda i elemenata zgrade Dio 1-5	
EN 13541	Staklo u zgradama - Sigurnosno stakljenje - Testiranje i klasifikacija otpornosti na eksplozivni pritisak	
EN 14351	Prozori i vrata - Standard za proizvod, karakteristike performansi	
EN 14600	Vrata i otvarajući prozori sa protivpožarnim i/ili protivdinim karaketsikama - Zahtjevi i klasifikacija	
EN 14608	Prozori - Definisane otpornosti na istezaanje	
EN 14609	Prozori - Definisane otpornosti na statičko izvijanje	



ALUMIL

Building excellence every day



Centrala grupacije/Head office of group:

ALUMIL SA
Industrial Area
61100 Kilkis
Greece
tel: 0030 23 41079300
www.alumil.com
info@alumil.com

Centrala BiH/Head office in BiH:

Njegoševa bb
75440 Vlasenica
tel: 00387 56 733750
00387 56 733720
www.alumil.ba
www.alpro-vl.com
bhaluminium@alpro-vl.com

PJ Sarajevo

Halilovići 6
71000 Sarajevo
tel: 00387 33 766275
00387 33 766276

PJ Banja Luka

Glamočani bb
78250 Laktaši
tel: 00387 51 508 630
00387 51 508 631

